

CONCEPT PLAN

THE CRESCENT AT CENTRAL PARK OF GAHANNA

PREPARED FOR CANINI AND ASSOCIATES, LTD.
DATE: 7.29.20

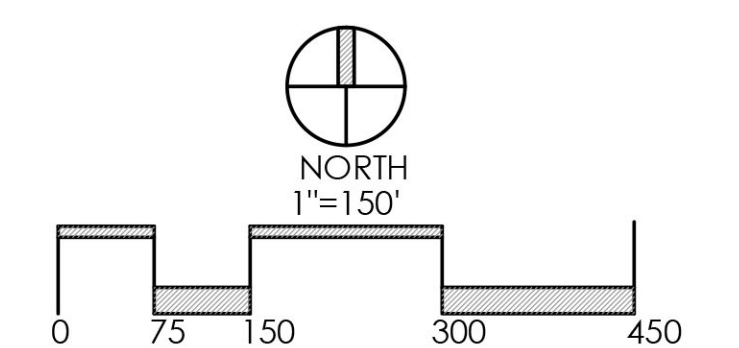

Faris Planning & Design
LAND PLANNING • LANDSCAPE ARCHITECTURE
243 N. 6th Street Suite #01 Columbus, OH 43216
p (614) 487-1944 www.farisplanninganddesign.com