



DEPARTMENT OF PLANNING

ZONING DIVISION  
200 S. Hamilton Road  
Gahanna, Ohio 43230  
614-342-4025  
zoning@gahanna.gov  
www.gahanna.gov

REZONING APPLICATION

PROPERTY INFORMATION			
Project/Property Address: Morse Road <i>5503 Morse Rd</i>		Project Name/Business Name: Morse Road 14	
Parcel #: 025-011219	Current Zoning: (see <a href="#">Map</a> )	<input type="text" value="ER-1"/>	Acreage: 13.96

ZONING CHANGE SPECIFICATIONS	
Proposed Use/Reason for Request: Rezone to MFRD for multi-family development	Proposed Zoning: MFRD

APPLICANT INFORMATION	
Applicant Name (Primary Contact): <i>Scott R. Harper, AIA, NCARB</i>	Applicant Address: <i>424 A Beecher Road</i>
Applicant E-mail: <i>scott@harperae.com</i>	Applicant Phone: <i>614-496-9097</i>
Business Name (if applicable): <i>Harper Architectural Studio, LLC</i>	

ADDITIONAL CONTACTS	
*Please list all applicable contacts for correspondence*	
Name(s)	Contact Information (phone/email)
Property Owner Name: <i>(if different from Applicant)</i>	Property Owner Contact Information (phone no./email):

ADDITIONAL INFORMATION ON NEXT PAGE....

INTERNAL USE

Zoning File No. *2-0049-2021*

RECEIVED: *KAW*

DATE: *2-18-22*

PAID: *1500.00*

DATE: *2-18-22*

Updated Aug 2021



DEPARTMENT OF PLANNING

### REZONING APPLICATION - SUBMISSION REQUIREMENTS

TO BE COMPLETED/SUBMITTED BY THE APPLICANT:	
1.	Review Gahanna Code Chapter <a href="#">1133</a> & <a href="#">1152</a> for Limited Overlay & ROD Applicants (visit <a href="#">Zoning Code</a> )
2.	Survey of property certified by registered surveyor (11"x17")
3.	Legal description of property certified by registered surveyor (11"x17")
4.	Limitation Text (Limited Overlay or ROD zoning applicants only)
5.	Development Plan (Limited Overlay or ROD zoning applicants only)
6.	Traffic Impact Study (labeled as such) - If any use permitted in the requested zone district could generate 100+ peak hour directional trips, or 1,000+ vehicle trips/day; the traffic study should contrast the daily peak hour trip generation rates for representative use in the requested zoning district.
7.	Conceptual plan (labeled as such) - Demonstrating that the site could be developed with representative uses permitted in the requested zoning district meeting requirements for setbacks, buffers, access spacing, parking, and other site design factors.
8.	Environmental assessment (labeled as such) - describing site features such as soil conditions and drainage patterns and anticipated impacts created by the host of uses permitted in the requested zoning district.
9.	Written statement on a separate sheet responding to the six (6) elements listed in Zoning Code Chapter <a href="#">1133.03(b)</a> . The City's land use plans can be found under the <a href="#">Planning</a> page on the City's website.
10.	List of contiguous property owners & their mailing address
11.	Two sets of pre-printed mailing labels for all contiguous property owners
12.	Application fee (in accordance with the <a href="#">Building &amp; Zoning Fee Schedule</a> )
13.	Application & all supporting documents submitted in digital format
14.	Application & all supporting documents submitted in hardcopy format
15.	<b>PLEASE NOTE</b> – Staff will place one zoning sign per public street frontage in accordance with Zoning Code Chapter <a href="#">1133.02</a> no less than 14 days prior to the public hearing date.
16.	Authorization Consent Form Complete & Notarized (see page 3)

#### APPLICANT SIGNATURE BELOW CONFIRMS THE SUBMISSION REQUIREMENTS HAVE BEEN COMPLETED

I certify that the information on this application is complete and accurate to the best of my knowledge, and that the project as described, if approved, will be completed in accordance with the conditions and terms of that approval.

Applicant Signature: 

Date: 2/17/22

#### PLEASE NOTE:

The Public Hearing will not occur until the City of Gahanna reviews the Application for Code Consistency. Applications that are not consistent with the code will not be scheduled for hearing.

**AUTHORIZATION CONSENT FORM**

*(must sign in the presence of a notary)*

If you are filling out more than one application for the same project & address, you may submit a copy of this form with additional applications.

PROPERTY OWNER

**IF THE PROPERTY OWNER IS THE APPLICANT, SKIP TO NEXT SECTION**

As the property owner/authorized owner's representative of the subject property listed on this application, hereby authorize the applicant/representative to act in all matters pertaining to the processing and approval of this application, including modifying the project. I agree to be bound by all terms and agreements made by the applicant/representative.

Monica Morgan Whitehead

(property owner name printed)

Monica Morgan Whitehead

(property owner signature)

FEB 14 2022

(date)

FEB 14 2022

Subscribed and sworn to before me on this \_\_\_\_\_ day of \_\_\_\_\_, 20\_\_\_\_.

State of OHIO, FRANKLIN County of \_\_\_\_\_

Notary Public Signature: \_\_\_\_\_

Steven B. VanSlyck, Attorney at Law  
Notary Public - State of Ohio  
My Commission Has No Expiration Date



Applicant/Property Owner/Representative

**AGREEMENT TO COMPLY AS APPROVED** As the applicant/representative/owner of the subject property listed on this application, I hereby agree that the project will be completed as approved with any conditions and terms of the approval, and any proposed changes to the approval shall be submitted for review and approval to City staff.

**AUTHORIZATION TO VISIT THE PROPERTY** I hereby authorize City representatives to visit, photograph and post notice (if applicable) on the subject property as described.

**APPLICATION SUBMISSION CERTIFICATION** I hereby certify that the information on this application is complete and accurate to the best of my knowledge.

SCOTT R. HARPER

(applicant/representative/property owner name printed)

(applicant/representative/property owner signature)

2/17/22

(date)

FEB 17 2022

Subscribed and sworn to before me on this \_\_\_\_\_ day of \_\_\_\_\_, 20\_\_\_\_.

State of OHIO, FRANKLIN County of \_\_\_\_\_

Notary Public Signature: \_\_\_\_\_

Steven B. VanSlyck, Attorney at Law  
Notary Public - State of Ohio  
My Commission Has No Expiration Date



Updated Aug 2021

# Harper Architectural Studio, LLC

Thursday, June 9, 2022

Mr. Michael Blackford, Director of Planning  
Ms. Kelly Wicker, Planning and Zoning Coordinator  
Department of Planning  
City of Gahanna  
200 S. Hamilton Road  
Gahanna, Ohio 43230

Re: Resubmission for Morse Road Multi-Family Development

Michael, Kelly,

Please find herein our revised site plan and response to the City comments received on May 17th, 2022 related to the rezoning application for the property on Morse Road. We are submitting the response for the rezoning application only.

Our site plan has been revised to show a total of 251 units which is within the permitted density of 18 units per acre. Please note that the developer will have one non leasable permanent model that will be located close to the clubhouse and leasing office. Please disregard our previous site plan submissions and review only the attached site plan which is dated June 9, 2022.

The site plan has also been revised to respond to the engineering review regarding the required 60' dedication corridor along Morse Road. This is consistent with the City of Columbus Multimodal Thoroughfare Plan.

Responding to staff comments in order:

## **Fire District**

1. The fire department had no objection to the Rezoning.

## **Parks**

2. The concern with regard to the number of trees to be removed is noted and we are committed to save as many existing on-site trees as possible. We will focus our efforts to minimize the impact. We will hire an arborist to work with us to assist us in the protection of the trees throughout the project. We will have our arborist meet with the Parks Department of the City in developing the most impactful tree replacement program. During construction, we will invite and welcome the City's arborist or any designated Park's Department personnel to meet on site periodically and advise us of any necessary improvement towards tree protection. Consistent with the Park's Department objective, our goal is also to try and save as many significant trees as possible and then plant additional trees based on the City's code requirements.

## **Planning**

3. *Informational Comment* - The setback of 25'-0" is noted. The setback shown on the revised site plan is 25'-0" from the newly required right of way. From the City engineering comments a new right of way dedication will be required with 60'-0" from the centerline of Morse Road.

4. *Informational Comment* - The applicant is aware that additional applications and a final development plan, and design review application will be required upon the successful rezoning on the property.

Harper Architectural Studio, LLC

5. *Informational Comment* - The final development plan shall include 15% minimum of the site for usable open space. This required minimum shall be quantified and delineated on the final development plan.

6. *Informational Comment* - The required buffer zones shall be provided and shall be included in the final development plan and design review submittals.

7. *Informational Comment* - No dwelling units in this proposed community will be less than 700 SF.

8. Chapter 1109.08(b)

The developer is working on a response and approach regarding the land dedication. The developer has initiated an appraiser and the appraisal is forthcoming and will be provided to the City planning department as soon as possible.

9. Please note that any previously submitted site plans are void. Please use the site plan included with this letter and submission. Please see the attached site plan dated 6/9/22.

10. Please reference the herein attached revised site plan for the development. The total proposed number of units is now (251) with (1) permanent non leasable model. This is within the density permitted of 18 units per acre. Please also note that the total number of parking spaces now provides a minimum of 2 parking spaces per dwelling unit.

**Engineering**

11. *Informational Comment* - This comment is noted. The feasibility of roadway infrastructure will be further reviewed as part of the Final Development Plan application.

12. *Informational Comment* - This comment is noted. The civil engineer will address the required sanitary design as part of the final development plan.

13. The updated reference of sanitary sewer to note appropriate 10" sanitary main constructed under SA-692 / CC-10438 has been revised.

14. *Informational Comment* - This comment is noted. Water and Sewer fees have been updated for 2022.

15. The feasibility report has been updated to note connection of the two existing 8" water mains to the east and west of the site. The site will be served from this proposed public 8" main crossing.

Thank you,



Scott R. Harper, AIA, NCARB  
SRH/p



June 9<sup>th</sup>, 2022

The Stonehenge Company  
147 N. High Street  
Gahanna, Ohio 43230  
Attn. Mo Dioun

**RE: Morse Road Apartments | Feasibility Study**

Dear Mr. Dioun,

At this time, we have researched the utility availability, roadway infrastructure needs, and general feasibility for the Morse Road Apartments development currently proposed off Morse Road in Gahanna, Ohio. The proposed 14-acre parcel, (PID # 025-011219-00), as proposed would be developed with a multi-building apartment complex, with clubhouse building.

### **Roadway Infrastructure**

The site is currently proposed with two accesses to Morse Road; a full access to the northeast inline with Preserve Crossing Boulevard and a right-in & right out with left out central to the site.

A Traffic Study has been prepared for the proposed development. Based on the study, a right-turn lane will be warranted for the central right-in & right-out with left out. Additionally, a left turn line will be required for the full access point to the northeast.

### **Sanitary Sewer**

Sanitary service to the site is accessible through an existing 10" sanitary constructed under SA-692 / CC-10438 and located in the development to the south, which has already been stubbed north for future connection. The site could be served through a sanitary main extension throughout to provide direct access for sanitary laterals from the proposed buildings. Per City of Columbus record plans CC-10438, the existing sanitary main was sized to allow future connection of the proposed 14-acre parcel. The City of Columbus' Sewer Atlas map has been included in Appendix A for reference.

The City of Gahanna utilizes the City of Columbus for waste water treatment. The City of Gahanna will collect system capacity charges for the development based on the domestic water tap. Additionally, permit and inspection fees of \$80 and a front footage charge of \$30 / front footage apply. Sample capacity charges are noted below per the City of Gahanna's 2021 Water and Sewer Connection Charges document:

- For a 4" domestic service, there is a system capacity charge of \$88,790.
- For a 6" domestic service, there is a system capacity charge of \$177,581.
- For an 8" domestic service, there is a system capacity charge of \$284,130.

### **Water Service**

Water service to the site is currently accessible through two existing 8" water mains located to the east and west of the site. A new public 8" water main across the Morse Road frontage will be required to connect these two existing mains. The site could be served through private domestic / fire loop(s) constructing additional fire hydrants and allowing direct access for building services throughout. Flow

tests have been requested at this time, although we do not have any current flow test data at this moment. However, based on our knowledge of the area we expect that the waterline has sufficient capacity to serve a development of this size. The City of Columbus' Water Atlas map has been included in Appendix B for reference.

The City of Gahanna receives City of Columbus water as a master-metered community. The City of Gahanna will collect water meter and system capacity charges based on the size(s) of the domestic and fire taps. Sample capacity / meter charges are noted below per the City of Gahanna's 2021 Water and Sewer Connection Charges document:

- For a 4" domestic service, there is a system capacity charge of \$47,775 and a meter service fee of up to \$3,483.
- For a 6" domestic service, there is a system capacity charge of \$108,529 and a meter service fee of up to \$5,633.
- For an 8" combined service, there is a system capacity charge of \$191,100 and a meter service fee of up to \$7,485.
- For a sole 8" fire service, there is a system capacity charge of \$95,550 and a meter charge of up to \$14,085.

### **Storm Water**

There is existing storm sewer along the north, east, and south property lines, with optimal access coming along the eastern property line. Access is currently shown through the use of an existing 24" storm sewer run along the southeast corner of the site continuing on the adjacent property south and ultimately southeast. Based on the size of the sewer run, it appears as though the sewer has been sized for the proposed site's tributary area. Water quality and water quantity detention shall be provided upstream of this connection to the City's storm sewer.

Water quality and water quantity detention are currently anticipated to be provided through the combination of roof top storage, parking lot ponding, oversized pipe, and detention basins spread throughout the site. As shown, there is a proposed basin located central to the site that will provide water quality drawdown for the property. Various detention areas will be utilized to meet the City of Gahanna's detention requirements. The proposed site will meet the requirements set forth by both the City of Gahanna and the Ohio EPA.

### **Gas Service**

Columbia Gas has natural gas infrastructure located in Morse Road near the site's northeast property corner. Additionally, Columbia Gas has provided a schematic detailing additional infrastructure in easement on the adjacent property to the east. Schematic information has been included in Appendix C.

### **Electric Service**

AEP has infrastructure located throughout the Morse Road right-of-way. Schematic information has been included in Appendix D.

### **Site Soils**

According to the USDA NRCS Web Soil Survey, the site exhibits three different soil types; approximately 74% Bennington silt loam, 2 to 6 percent slopes, approximately 17% Condit silt loam, 0 to 1 percent

slopes, and approximately 9% Cardington silt loam, 2 to 6 percent slopes. The western majority of the site is occupied by Bennington silt loam, with smaller pockets of Condit and Cardington silt loam in the eastern portion of the site. All three soils are classified under hydrologic soil group C/D. A soil report has been included in Appendix E for reference.

### **Topography**

The site exhibits significant grade changes throughout with slopes generally leading from west to east. Along the northern property line, there is an approximate 7-8' of fall from the northwest corner to the northeast. Further south, there is a high point approximately a quarter of the way from west to east leading with

### **Flood Plain**

According to FEMA FIRM panel 39049C0211K, this site is not located within either the 100-year or 500-year flood hazard zones. A FEMA FIRMette has been included in Appendix F for reference.

### **Wetlands**

Through field survey, it has been determined that there may be two possible wetland areas located on the site. Of these two possible areas, the larger is approximately 1.20 to 1.45 acres in the eastern third of the property, while the smaller one is approximately 0.18 acres central to the property. Both areas can be seen noted on the ALTA survey included in Appendix G.

In order to develop the site as proposed, the two wetland areas must be mitigated per requirements set forth both by both the Ohio EPA and the Army Corps of Engineers. We believe that these are isolated wetlands and will be in the jurisdiction of the Ohio EPA only. Any required mitigation process with the EPA will begin as soon as the Army Corps determination confirms that these areas are isolated wetlands. If necessary, wetland credits are available for purchase in the area. The site has been submitted to the Army Corps of Engineers for jurisdictional determination.

### **Trees**

The site is wooded in some areas. It is expected that will be removed as part of the Final Development Plan. Per Gahanna's City Code, a minimum of one shade tree caliper inch per 1,000 square feet of impervious surface shall be required as part of the development. A preliminary estimate of approximately 350-360 caliper inches of shade trees shall be required per this section.

Existing trees to be preserved may be used to meet this requirement. Existing trees between 6 and 19 inches in diameter are credited as 1.0 credit per inch, trees 20 inches in diameter or larger are credited as 1.5 credits per inch, and preferred species trees 20 inches in diameter or larger can be credited as 2.0 credits per inch. Beyond preservation credits, shade trees between 1.5 and 2.5 caliper inches shall be installed to meet requirements. Additionally, contribution can be made to the Tree Replacement Fund in lieu of meeting the full caliper inch required onsite.

### **Zoning**

The site is currently zoned as ER-1 (Estate Residential). The property is currently in the process of being rezoned for the proposed development. Additionally, the site will require the approval of a Final Development Plan and a Design Review / Certificate of Appropriateness Application, both cases going in front of the City Planning Commission.



Sincerely,  
V3 Companies

A handwritten signature in black ink that reads "Joshua Miller". The signature is written in a cursive style with a large initial 'J'.

Joshua Miller, P.E.  
Project Engineer, Land Development

# APPENDICES

**Appendix A – COC Sewer Atlas Map**

**Appendix B – COC Water Atlas Map**

**Appendix C – Columbia Gas Infrastructure Schematic**

**Appendix D – AEP Infrastructure Schematic**

**Appendix E – Soil Report**

**Appendix F – FEMA FIRMette Map**

**Appendix G – ALTA Survey**

379	380	381
306	307	382
241	308	383

- Sewer Main**
  - Sewer : Other
  - Combined: Existing
  - Combined: Proposed
  - Combined: Abandoned
  - Sanitary: Existing
  - Sanitary: Proposed
  - Sanitary: Abandoned
  - Storm: Existing
  - Storm: Proposed
  - Storm: Abandoned
- Sewer Manhole**
  - Combined
  - Sanitary
  - Storm
  - Storm Inlet
  - Flow Monitor
- Sewer Blind Connect**
  - Combined
  - Sanitary
  - Storm
- Sewer Main Change**
  - Combined
  - Sanitary
  - Storm
- Sewer Pipe End**
  - Headwall
  - Not Delivered
  - Plain
  - Unknown
- Sewer Clean Out**
  - Sanitary
  - Storm
- Sewer Flow Regulator**
  - Combined
  - Sanitary
  - Storm
- Sewer Pump Station**
  - Sanitary
  - Storm
- DOSD BMP Locations**
  - DOSD BMP Locations
- Sewer Structure**
  - Sewer Structure
  - Sewer Sluice Gate
  - Sewer Flap Gate
  - Sewer Outfall
  - Sewer Bulkhead
  - Sewer Treatment Plant
  - WCLPP Line of Protection
- Open Channel**
  - Sewer Sheds
  - Columbus Corporate Boundary
  - NOT City of Columbus
  - County Boundaries

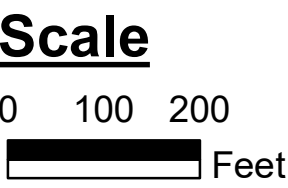

While every reasonable effort has been made to ensure the accuracy of this information, it is provided without warranty of any kind, whether expressed or implied. The City of Columbus assumes no liability arising from any use of this information and is not responsible for its accuracy or completeness. Those using this information for any reason are solely responsible for its use and do so at their own risk.

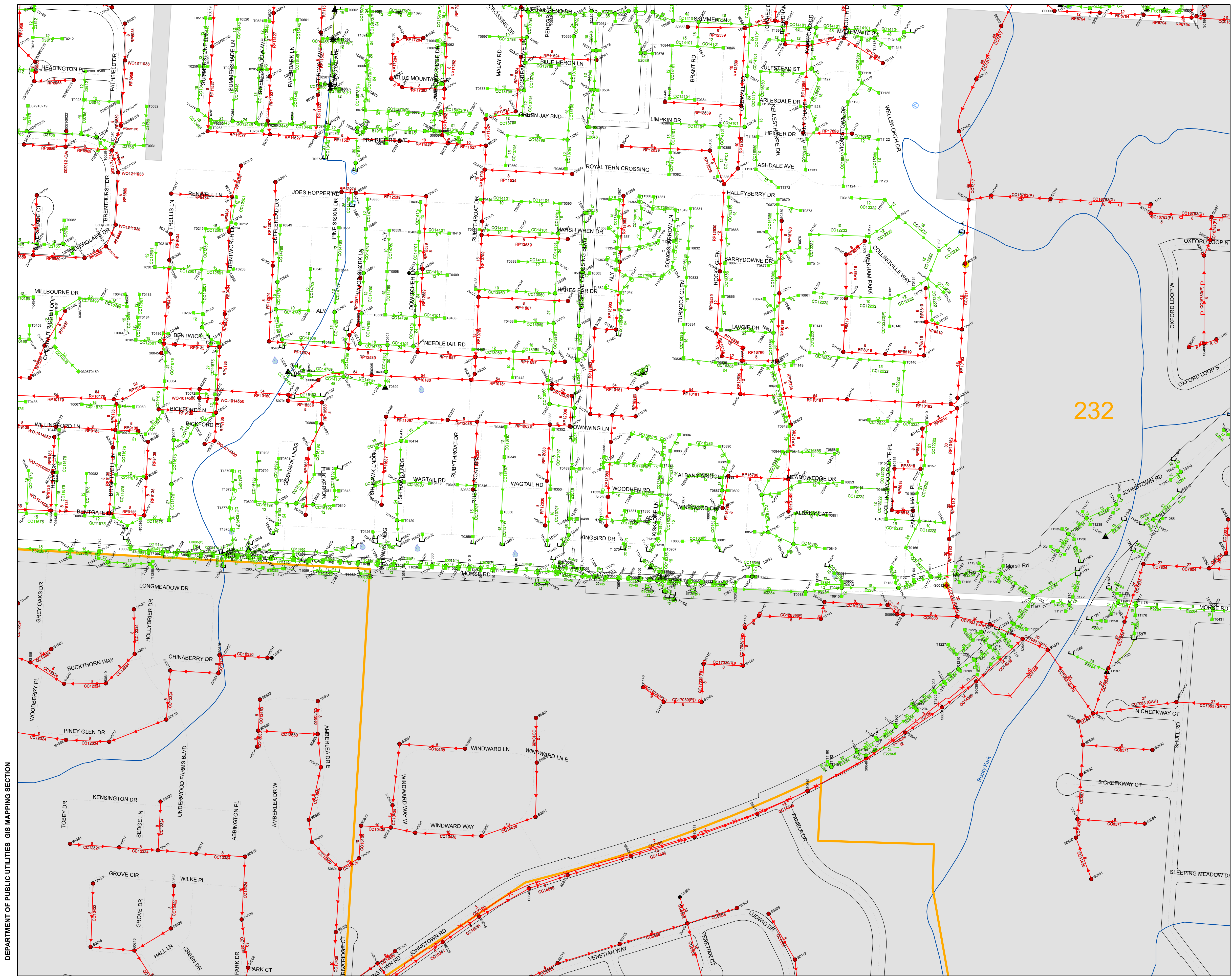

DEPARTMENT OF PUBLIC UTILITIES GIS MAPPING SECTION

CREATED: 12/14/2021

# Sewer Atlas 307

379	380	381
306	307	382
241	308	383

**Water Main**

- Water: Other
- Main: In Service
- - - Main: Emerg Connect
- ⊖ Main: Out of Service
- ✕ Main: Abandoned
- ⊕ Main: Proposed
- - - Hydrant Lateral: In Service
- ✕ - - - Hydrant Lateral: Abandoned
- Raw: In Service
- ⊖ Raw: Out of Service
- ✕ Raw: Abandoned
- ⊖ Sludge: In Service

**Water Hydrant**

- ⬢ Others
- ⬢ Columbus
- Columbus Corporate Boundary
- NOT City of Columbus

**Scale**

0 100 200  
Feet

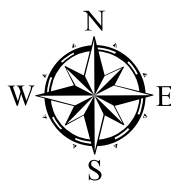

*While every reasonable effort has been made to ensure the accuracy of this information, it is provided without warranty of any kind, whether expressed or implied. The City of Columbus assumes no liability arising from any use of this information and is not responsible for its accuracy or completeness. Those using this information for any reason are solely responsible for its use and do so at their own risk.*

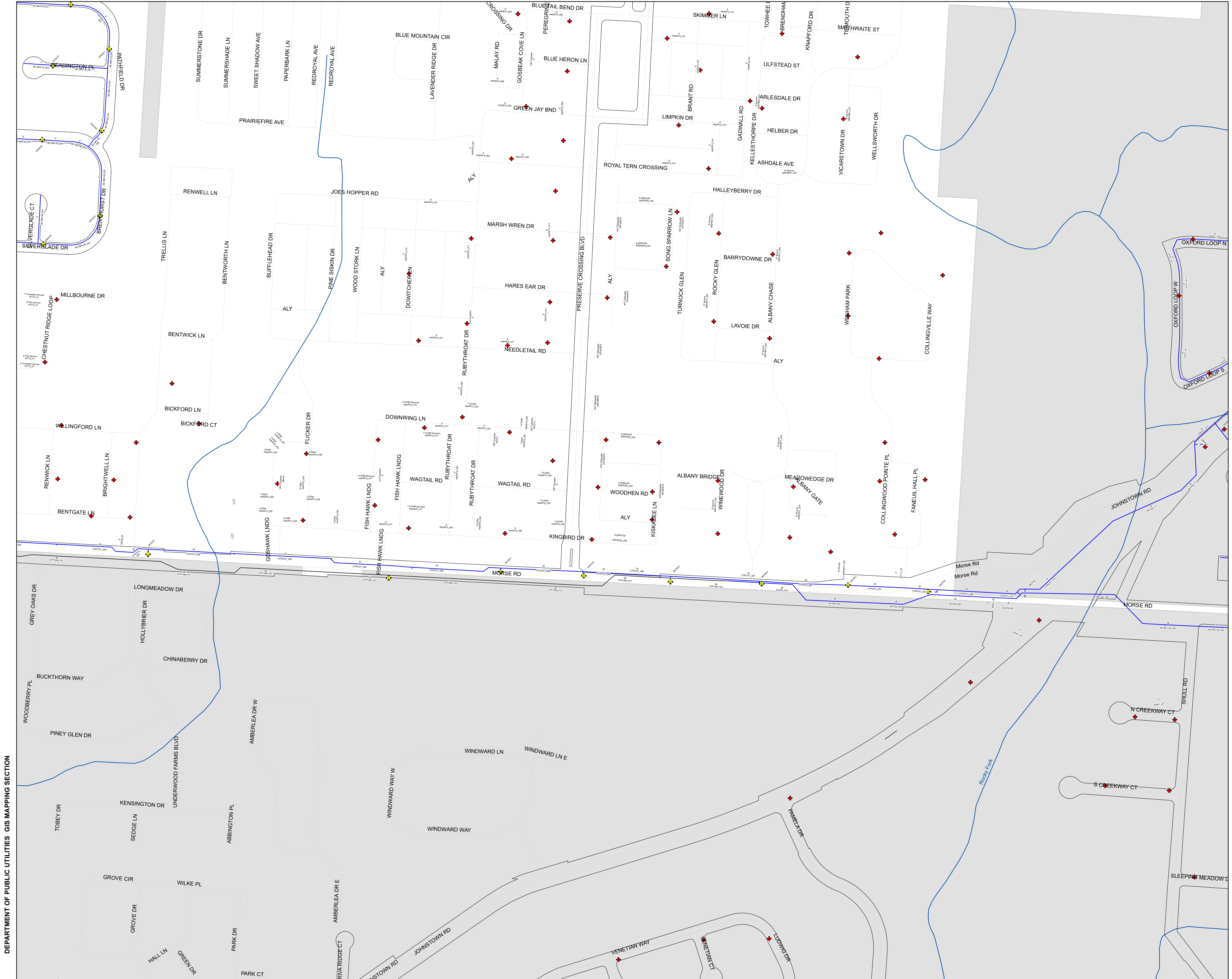

DEPARTMENT OF PUBLIC UTILITIES GIS MAPPING SECTION

CREATED: 12/14/2021

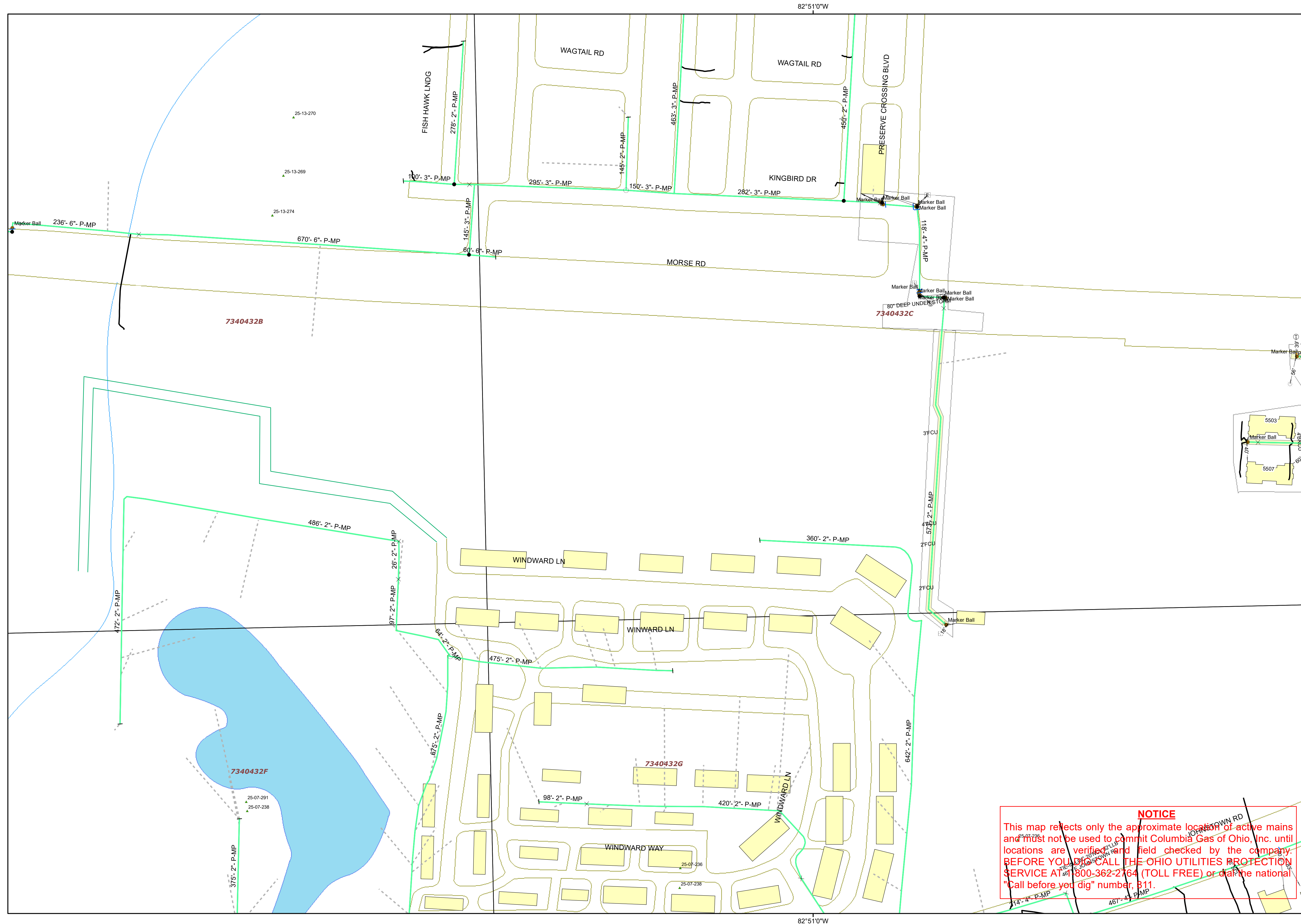
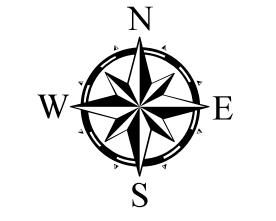

**Legend:**

**Gas Valve**

- ⊗ <all other values>
- ⊗ Non-Critical Valve
- Critical Valve

**Gas Mains: Distribution & Foreign**

- Distribution
- Foreign

**Gas Mains: DOT Transmission & Other**

- Transmission
- DOT Transmission
- DOT Gathering
- Pseudo-Transmission

**Gas Service**

- - - <all other values>
- - - Steel
- - - Cast Iron
- - - Wrought Iron
- - - Plastic
- - - Other
- - - Fittings
- Historic Map

**NOTICE**  
This map reflects only the approximate location of active mains and must not be used to commit Columbia Gas of Ohio, Inc. until locations are verified and field checked by the company. BEFORE YOU DIG CALL THE OHIO UTILITIES PROTECTION SERVICE AT 1-800-362-2764 (TOLL FREE) or dial the national "Call before you dig" number, 811.

Prepared by:	
Date:	
Coordinates:	GCS (Lat/Long) in DMS. Datum: WGS84

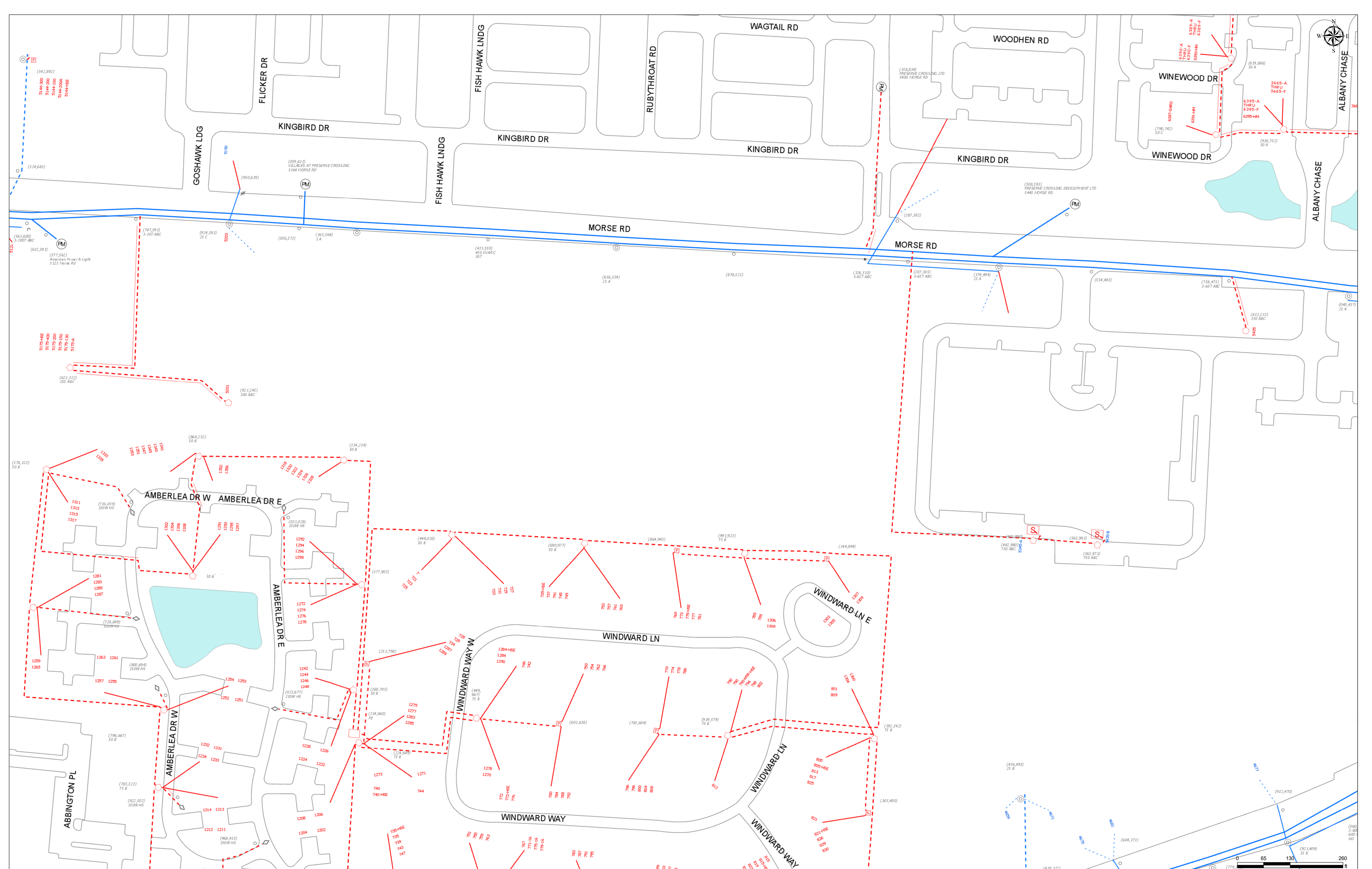

AEP Distribution Web Map

Disclosure Note:  
 This map contains copyrighted and confidential material and may not be reproduced or copied in any form without the written consent of American Electric Power.  
 The map is provided as a reference only and the information contained herein should not be relied upon exclusively to design, construct, excavate or prepare plans.  
 If excavation or digging is to be performed, the excavator must contact the Utility One-Call System in the locale where the work is to be performed.

# Soil Map

---

The soil map section includes the soil map for the defined area of interest, a list of soil map units on the map and extent of each map unit, and cartographic symbols displayed on the map. Also presented are various metadata about data used to produce the map, and a description of each soil map unit.

# Custom Soil Resource Report Soil Map

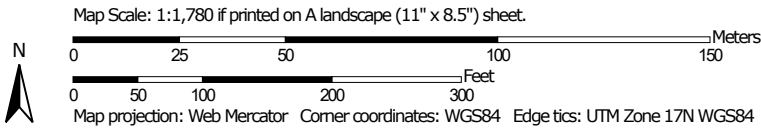
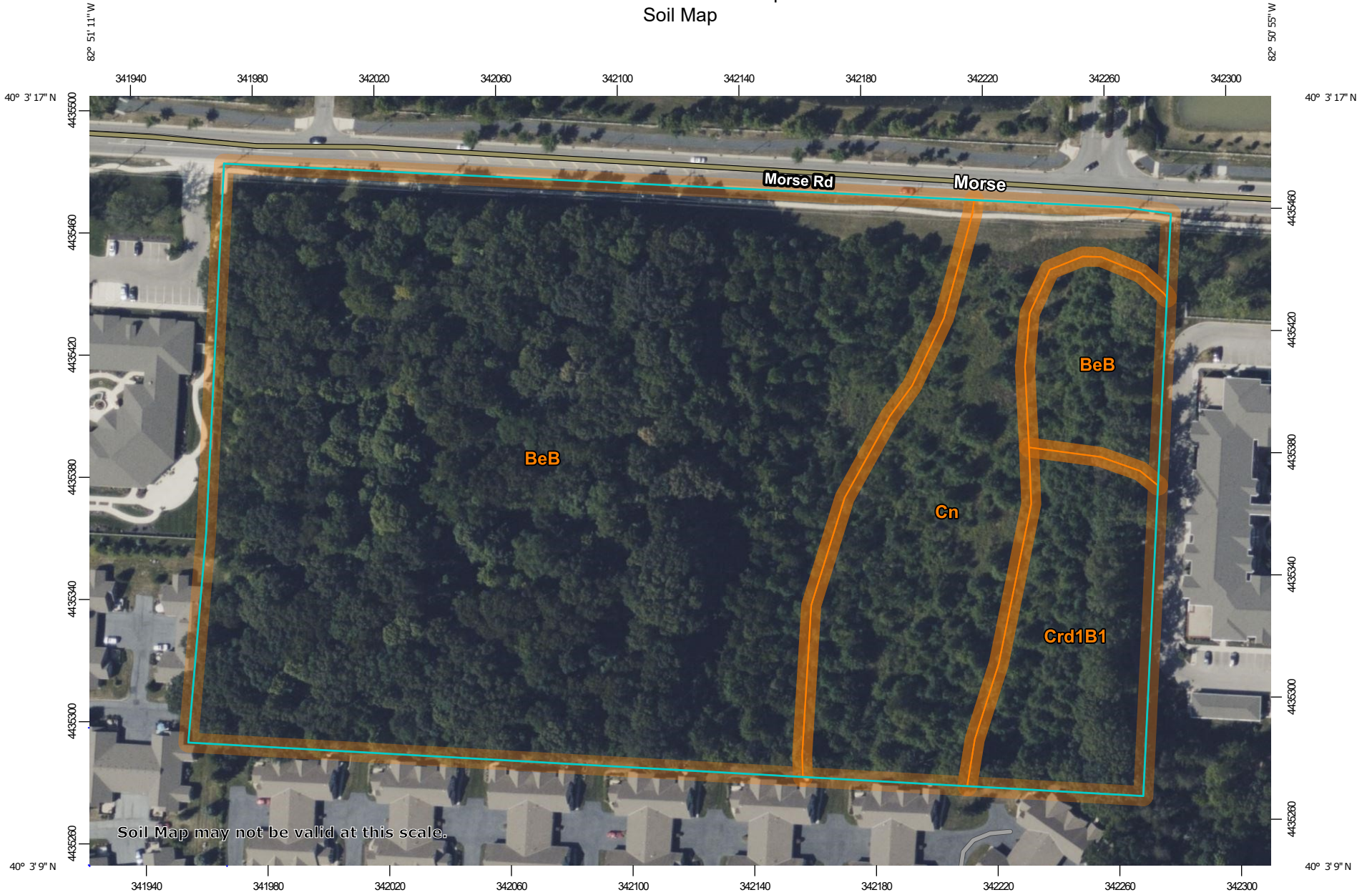



### MAP LEGEND

**Area of Interest (AOI)**

 Area of Interest (AOI)

**Soils**

 Soil Map Unit Polygons

 Soil Map Unit Lines

 Soil Map Unit Points

**Special Point Features**

-  Blowout
-  Borrow Pit
-  Clay Spot
-  Closed Depression
-  Gravel Pit
-  Gravelly Spot
-  Landfill
-  Lava Flow
-  Marsh or swamp
-  Mine or Quarry
-  Miscellaneous Water
-  Perennial Water
-  Rock Outcrop
-  Saline Spot
-  Sandy Spot
-  Severely Eroded Spot
-  Sinkhole
-  Slide or Slip
-  Sodic Spot

-  Spoil Area
-  Stony Spot
-  Very Stony Spot
-  Wet Spot
-  Other
-  Special Line Features

**Water Features**

 Streams and Canals

**Transportation**

-  Rails
-  Interstate Highways
-  US Routes
-  Major Roads
-  Local Roads

**Background**

 Aerial Photography

### MAP INFORMATION

The soil surveys that comprise your AOI were mapped at 1:15,800.

Warning: Soil Map may not be valid at this scale.

Enlargement of maps beyond the scale of mapping can cause misunderstanding of the detail of mapping and accuracy of soil line placement. The maps do not show the small areas of contrasting soils that could have been shown at a more detailed scale.

Please rely on the bar scale on each map sheet for map measurements.

Source of Map: Natural Resources Conservation Service  
 Web Soil Survey URL:  
 Coordinate System: Web Mercator (EPSG:3857)

Maps from the Web Soil Survey are based on the Web Mercator projection, which preserves direction and shape but distorts distance and area. A projection that preserves area, such as the Albers equal-area conic projection, should be used if more accurate calculations of distance or area are required.

This product is generated from the USDA-NRCS certified data as of the version date(s) listed below.

Soil Survey Area: Franklin County, Ohio  
 Survey Area Data: Version 20, Sep 7, 2021

Soil map units are labeled (as space allows) for map scales 1:50,000 or larger.

Date(s) aerial images were photographed: Apr 1, 2020—Oct 1, 2020

The orthophoto or other base map on which the soil lines were compiled and digitized probably differs from the background imagery displayed on these maps. As a result, some minor shifting of map unit boundaries may be evident.

## Map Unit Legend

Map Unit Symbol	Map Unit Name	Acres in AOI	Percent of AOI
BeB	Bennington silt loam, 2 to 6 percent slopes	11.0	74.2%
Cn	Condit silt loam, 0 to 1 percent slopes	2.5	17.0%
Crd1B1	Cardington silt loam, 2 to 6 percent slopes	1.3	8.8%
<b>Totals for Area of Interest</b>		<b>14.8</b>	<b>100.0%</b>

## Map Unit Descriptions

The map units delineated on the detailed soil maps in a soil survey represent the soils or miscellaneous areas in the survey area. The map unit descriptions, along with the maps, can be used to determine the composition and properties of a unit.

A map unit delineation on a soil map represents an area dominated by one or more major kinds of soil or miscellaneous areas. A map unit is identified and named according to the taxonomic classification of the dominant soils. Within a taxonomic class there are precisely defined limits for the properties of the soils. On the landscape, however, the soils are natural phenomena, and they have the characteristic variability of all natural phenomena. Thus, the range of some observed properties may extend beyond the limits defined for a taxonomic class. Areas of soils of a single taxonomic class rarely, if ever, can be mapped without including areas of other taxonomic classes. Consequently, every map unit is made up of the soils or miscellaneous areas for which it is named and some minor components that belong to taxonomic classes other than those of the major soils.

Most minor soils have properties similar to those of the dominant soil or soils in the map unit, and thus they do not affect use and management. These are called noncontrasting, or similar, components. They may or may not be mentioned in a particular map unit description. Other minor components, however, have properties and behavioral characteristics divergent enough to affect use or to require different management. These are called contrasting, or dissimilar, components. They generally are in small areas and could not be mapped separately because of the scale used. Some small areas of strongly contrasting soils or miscellaneous areas are identified by a special symbol on the maps. If included in the database for a given area, the contrasting minor components are identified in the map unit descriptions along with some characteristics of each. A few areas of minor components may not have been observed, and consequently they are not mentioned in the descriptions, especially where the pattern was so complex that it was impractical to make enough observations to identify all the soils and miscellaneous areas on the landscape.

The presence of minor components in a map unit in no way diminishes the usefulness or accuracy of the data. The objective of mapping is not to delineate pure taxonomic classes but rather to separate the landscape into landforms or

## Custom Soil Resource Report

landform segments that have similar use and management requirements. The delineation of such segments on the map provides sufficient information for the development of resource plans. If intensive use of small areas is planned, however, onsite investigation is needed to define and locate the soils and miscellaneous areas.

An identifying symbol precedes the map unit name in the map unit descriptions. Each description includes general facts about the unit and gives important soil properties and qualities.

Soils that have profiles that are almost alike make up a *soil series*. Except for differences in texture of the surface layer, all the soils of a series have major horizons that are similar in composition, thickness, and arrangement.

Soils of one series can differ in texture of the surface layer, slope, stoniness, salinity, degree of erosion, and other characteristics that affect their use. On the basis of such differences, a soil series is divided into *soil phases*. Most of the areas shown on the detailed soil maps are phases of soil series. The name of a soil phase commonly indicates a feature that affects use or management. For example, Alpha silt loam, 0 to 2 percent slopes, is a phase of the Alpha series.

Some map units are made up of two or more major soils or miscellaneous areas. These map units are complexes, associations, or undifferentiated groups.

A *complex* consists of two or more soils or miscellaneous areas in such an intricate pattern or in such small areas that they cannot be shown separately on the maps. The pattern and proportion of the soils or miscellaneous areas are somewhat similar in all areas. Alpha-Beta complex, 0 to 6 percent slopes, is an example.

An *association* is made up of two or more geographically associated soils or miscellaneous areas that are shown as one unit on the maps. Because of present or anticipated uses of the map units in the survey area, it was not considered practical or necessary to map the soils or miscellaneous areas separately. The pattern and relative proportion of the soils or miscellaneous areas are somewhat similar. Alpha-Beta association, 0 to 2 percent slopes, is an example.

An *undifferentiated group* is made up of two or more soils or miscellaneous areas that could be mapped individually but are mapped as one unit because similar interpretations can be made for use and management. The pattern and proportion of the soils or miscellaneous areas in a mapped area are not uniform. An area can be made up of only one of the major soils or miscellaneous areas, or it can be made up of all of them. Alpha and Beta soils, 0 to 2 percent slopes, is an example.

Some surveys include *miscellaneous areas*. Such areas have little or no soil material and support little or no vegetation. Rock outcrop is an example.

## Franklin County, Ohio

### BeB—Bennington silt loam, 2 to 6 percent slopes

#### Map Unit Setting

*National map unit symbol:* 2t6mb  
*Elevation:* 800 to 1,120 feet  
*Mean annual precipitation:* 34 to 42 inches  
*Mean annual air temperature:* 48 to 54 degrees F  
*Frost-free period:* 145 to 175 days  
*Farmland classification:* Prime farmland if drained

#### Map Unit Composition

*Bennington and similar soils:* 85 percent  
*Minor components:* 15 percent  
*Estimates are based on observations, descriptions, and transects of the mapunit.*

#### Description of Bennington

##### Setting

*Landform:* End moraines, ground moraines  
*Landform position (two-dimensional):* Backslope, footslope, summit  
*Landform position (three-dimensional):* Interfluve  
*Down-slope shape:* Concave, linear  
*Across-slope shape:* Linear  
*Parent material:* Wisconsin loamy till derived from sandstone and shale

##### Typical profile

*Ap - 0 to 9 inches:* silt loam  
*Bt - 9 to 29 inches:* silty clay loam  
*BCt - 29 to 40 inches:* silty clay loam  
*C - 40 to 79 inches:* clay loam

##### Properties and qualities

*Slope:* 2 to 6 percent  
*Depth to restrictive feature:* More than 80 inches  
*Drainage class:* Somewhat poorly drained  
*Runoff class:* High  
*Capacity of the most limiting layer to transmit water (Ksat):* Moderately low to moderately high (0.06 to 0.20 in/hr)  
*Depth to water table:* About 6 to 12 inches  
*Frequency of flooding:* None  
*Frequency of ponding:* None  
*Calcium carbonate, maximum content:* 22 percent  
*Maximum salinity:* Nonsaline to very slightly saline (0.0 to 2.0 mmhos/cm)  
*Available water supply, 0 to 60 inches:* Moderate (about 8.0 inches)

##### Interpretive groups

*Land capability classification (irrigated):* None specified  
*Land capability classification (nonirrigated):* 2e  
*Hydrologic Soil Group:* C/D  
*Ecological site:* F111EY502OH - Wet Till Ridge  
*Hydric soil rating:* No

## Minor Components

### Cardington

*Percent of map unit:* 9 percent  
*Landform:* End moraines, ground moraines  
*Landform position (two-dimensional):* Summit, shoulder, backslope  
*Landform position (three-dimensional):* Crest, side slope  
*Down-slope shape:* Convex, linear  
*Across-slope shape:* Convex  
*Ecological site:* F111EY503OH - Till Ridge  
*Hydric soil rating:* No

### Pewamo, low carbonate till

*Percent of map unit:* 3 percent  
*Landform:* Drainageways, depressions  
*Landform position (two-dimensional):* Toeslope  
*Landform position (three-dimensional):* Base slope  
*Down-slope shape:* Linear, concave  
*Across-slope shape:* Concave  
*Hydric soil rating:* Yes

### Condit

*Percent of map unit:* 3 percent  
*Landform:* Depressions, drainageways  
*Landform position (two-dimensional):* Toeslope  
*Landform position (three-dimensional):* Base slope  
*Down-slope shape:* Concave, linear  
*Across-slope shape:* Concave  
*Ecological site:* F111EY501OH - Till Depression  
*Hydric soil rating:* Yes

## Cn—Condit silt loam, 0 to 1 percent slopes

### Map Unit Setting

*National map unit symbol:* 2s1j0  
*Elevation:* 800 to 1,000 feet  
*Mean annual precipitation:* 34 to 42 inches  
*Mean annual air temperature:* 46 to 54 degrees F  
*Frost-free period:* 145 to 180 days  
*Farmland classification:* Prime farmland if drained

### Map Unit Composition

*Condit and similar soils:* 90 percent  
*Minor components:* 10 percent  
*Estimates are based on observations, descriptions, and transects of the mapunit.*

### Description of Condit

#### Setting

*Landform:* End moraines, ground moraines

## Custom Soil Resource Report

*Landform position (two-dimensional):* Toeslope

*Landform position (three-dimensional):* Dip

*Down-slope shape:* Linear

*Across-slope shape:* Concave

*Parent material:* Wisconsin loamy till derived from limestone, sandstone, and shale

### Typical profile

*Ap - 0 to 10 inches:* silt loam

*Bt - 10 to 54 inches:* silty clay loam

*C - 54 to 79 inches:* silty clay loam

### Properties and qualities

*Slope:* 0 to 1 percent

*Depth to restrictive feature:* More than 80 inches

*Drainage class:* Poorly drained

*Runoff class:* Negligible

*Capacity of the most limiting layer to transmit water (Ksat):* Moderately low to moderately high (0.06 to 0.20 in/hr)

*Depth to water table:* About 0 to 12 inches

*Frequency of flooding:* None

*Frequency of ponding:* Occasional

*Calcium carbonate, maximum content:* 20 percent

*Maximum salinity:* Nonsaline to very slightly saline (0.0 to 2.0 mmhos/cm)

*Available water supply, 0 to 60 inches:* Moderate (about 7.9 inches)

### Interpretive groups

*Land capability classification (irrigated):* None specified

*Land capability classification (nonirrigated):* 3w

*Hydrologic Soil Group:* C/D

*Ecological site:* F111EY501OH - Till Depression

*Hydric soil rating:* Yes

### Minor Components

#### Bennington

*Percent of map unit:* 4 percent

*Landform:* End moraines, ground moraines

*Landform position (two-dimensional):* Footslope, backslope

*Landform position (three-dimensional):* Rise

*Down-slope shape:* Linear

*Across-slope shape:* Linear

*Ecological site:* F111EY502OH - Wet Till Ridge

*Hydric soil rating:* No

#### Pewamo

*Percent of map unit:* 3 percent

*Landform:* Ground moraines, end moraines

*Landform position (two-dimensional):* Toeslope

*Landform position (three-dimensional):* Dip

*Down-slope shape:* Concave

*Across-slope shape:* Concave

*Other vegetative classification:* Mixed/Transitional (Mixed Native Vegetation)

*Hydric soil rating:* Yes

#### Condit, fine-loamy

*Percent of map unit:* 3 percent

*Landform:* End moraines, ground moraines

## Custom Soil Resource Report

*Landform position (two-dimensional):* Toeslope  
*Landform position (three-dimensional):* Dip  
*Down-slope shape:* Linear  
*Across-slope shape:* Concave  
*Ecological site:* F111EY501OH - Till Depression  
*Hydric soil rating:* Yes

### **Crd1B1—Cardington silt loam, 2 to 6 percent slopes**

#### **Map Unit Setting**

*National map unit symbol:* 2wvgd  
*Elevation:* 700 to 1,400 feet  
*Mean annual precipitation:* 34 to 42 inches  
*Mean annual air temperature:* 48 to 55 degrees F  
*Frost-free period:* 150 to 180 days  
*Farmland classification:* All areas are prime farmland

#### **Map Unit Composition**

*Cardington and similar soils:* 85 percent  
*Minor components:* 15 percent  
*Estimates are based on observations, descriptions, and transects of the mapunit.*

#### **Description of Cardington**

##### **Setting**

*Landform:* End moraines, ground moraines  
*Landform position (two-dimensional):* Summit, shoulder, backslope  
*Landform position (three-dimensional):* Crest, side slope  
*Down-slope shape:* Convex, linear  
*Across-slope shape:* Convex  
*Parent material:* Wisconsin loamy till derived from limestone, sandstone, and shale

##### **Typical profile**

*Ap - 0 to 9 inches:* silt loam  
*Bt - 9 to 34 inches:* silty clay loam  
*BC - 34 to 42 inches:* silty clay loam  
*C - 42 to 79 inches:* clay loam

##### **Properties and qualities**

*Slope:* 2 to 6 percent  
*Depth to restrictive feature:* More than 80 inches  
*Drainage class:* Moderately well drained  
*Runoff class:* Medium  
*Capacity of the most limiting layer to transmit water (Ksat):* Moderately low to moderately high (0.06 to 0.20 in/hr)  
*Depth to water table:* About 12 to 24 inches  
*Frequency of flooding:* None  
*Frequency of ponding:* None  
*Calcium carbonate, maximum content:* 22 percent  
*Maximum salinity:* Nonsaline to very slightly saline (0.0 to 2.0 mmhos/cm)

## Custom Soil Resource Report

*Available water supply, 0 to 60 inches:* Moderate (about 8.0 inches)

### **Interpretive groups**

*Land capability classification (irrigated):* None specified

*Land capability classification (nonirrigated):* 2e

*Hydrologic Soil Group:* C/D

*Ecological site:* F111EY503OH - Till Ridge

*Hydric soil rating:* No

### **Minor Components**

#### **Bennington**

*Percent of map unit:* 8 percent

*Landform:* End moraines, ground moraines

*Landform position (two-dimensional):* Backslope, footslope, summit

*Landform position (three-dimensional):* Interfluvium

*Down-slope shape:* Concave, linear

*Across-slope shape:* Linear

*Ecological site:* F111EY502OH - Wet Till Ridge

*Hydric soil rating:* No

#### **Condit**

*Percent of map unit:* 4 percent

*Landform:* Depressions, drainageways

*Landform position (two-dimensional):* Toeslope

*Landform position (three-dimensional):* Base slope

*Down-slope shape:* Concave, linear

*Across-slope shape:* Concave

*Ecological site:* F111EY501OH - Till Depression

*Hydric soil rating:* Yes

#### **Pewamo, low carbonate till**

*Percent of map unit:* 3 percent

*Landform:* Drainageways, depressions

*Landform position (two-dimensional):* Toeslope

*Landform position (three-dimensional):* Base slope

*Down-slope shape:* Linear, concave

*Across-slope shape:* Concave

*Hydric soil rating:* Yes



# National Flood Hazard Layer FIRMette



82°51'23"W 40°3'27"N

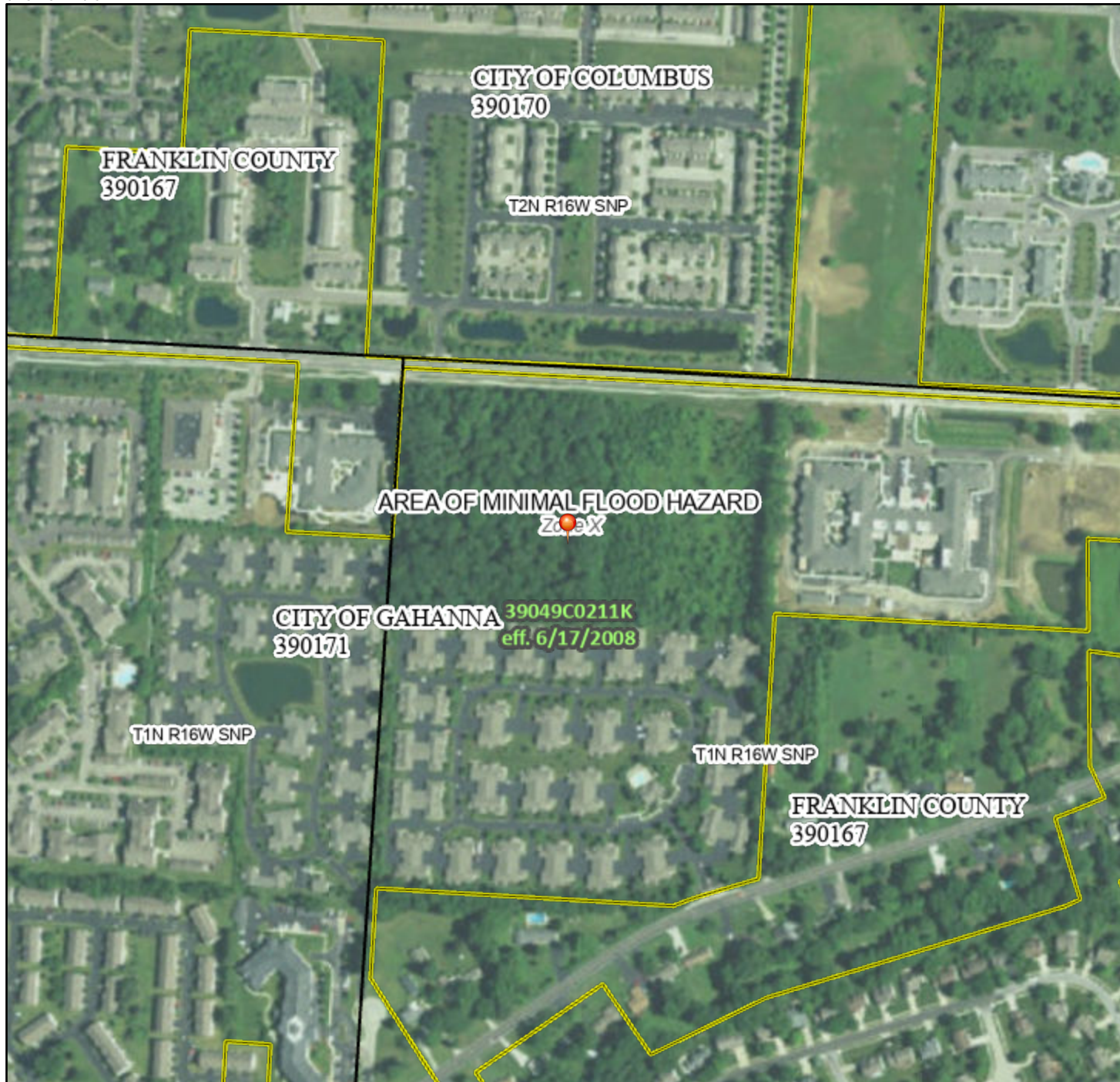

Basemap: USGS National Map: Orthoimagery: Data refreshed October, 2020

82°50'45"W 40°2'59"N

## Legend

SEE FIS REPORT FOR DETAILED LEGEND AND INDEX MAP FOR FIRM PANEL LAYOUT

SPECIAL FLOOD HAZARD AREAS		Without Base Flood Elevation (BFE) <i>Zone A, V, A99</i>
		With BFE or Depth <i>Zone AE, AO, AH, VE, AR</i>
		Regulatory Floodway
OTHER AREAS OF FLOOD HAZARD		0.2% Annual Chance Flood Hazard, Areas of 1% annual chance flood with average depth less than one foot or with drainage areas of less than one square mile <i>Zone X</i>
		Future Conditions 1% Annual Chance Flood Hazard <i>Zone X</i>
		Area with Reduced Flood Risk due to Levee. See Notes. <i>Zone X</i>
		Area with Flood Risk due to Levee <i>Zone D</i>
OTHER AREAS		NO SCREEN Area of Minimal Flood Hazard <i>Zone X</i>
		Effective LOMRs
GENERAL STRUCTURES		Area of Undetermined Flood Hazard <i>Zone D</i>
		Channel, Culvert, or Storm Sewer
		Levee, Dike, or Floodwall
OTHER FEATURES		20.2 Cross Sections with 1% Annual Chance
		17.5 Water Surface Elevation
		Coastal Transect
		Base Flood Elevation Line (BFE)
		Limit of Study
MAP PANELS		Jurisdiction Boundary
		Coastal Transect Baseline
		Profile Baseline
		Hydrographic Feature
		Digital Data Available
		No Digital Data Available
		Unmapped



The pin displayed on the map is an approximate point selected by the user and does not represent an authoritative property location.

This map complies with FEMA's standards for the use of digital flood maps if it is not void as described below. The basemap shown complies with FEMA's basemap accuracy standards

The flood hazard information is derived directly from the authoritative NFHL web services provided by FEMA. This map was exported on **4/5/2022 at 10:04 AM** and does not reflect changes or amendments subsequent to this date and time. The NFHL and effective information may change or become superseded by new data over time.

This map image is void if the one or more of the following map elements do not appear: basemap imagery, flood zone labels, legend, scale bar, map creation date, community identifiers, FIRM panel number, and FIRM effective date. Map images for unmapped and unmodernized areas cannot be used for regulatory purposes.

**TITLE DESCRIPTION**

The Land referred to herein below is situated in the County of Franklin, State of Ohio, and is described as follows: Real Property: Situated in the County of Franklin, in the State of Ohio, and in the Township of Jefferson.  
 Being part of Lot Number 4 of Subdivision of Lot Number 10 in Quarter Township 2, Township 1, Range 16, United States Military Lands, and being part of the same premises conveyed to said Harold R. Hukill by Howard L. Beem and wife by warranty deed dated July 29, 1942 (1924) and recorded in Deed Book 790, Page 78 (178), Recorder's Office, Franklin County, Ohio. Beginning at the northwest corner of Lot Number 4 being also the northwest corner of original Lot Number 10; thence east 60 rods to an iron pin; thence south 37 1/3 rods to a stake; thence west 60 rods to a stake; thence north 37 1/3 rods to the place of beginning, containing fourteen (14) acres of land.

**SCHEDULE "B" ITEMS**

FIRST AMERICAN TITLE INSURANCE COMPANY  
 COMMITMENT NO. 160567  
 EFFECTIVE DATE: NOVEMBER 15, 2021 AT 6:59 A.M.

Item 11 - D.B. 1079, Pg. 492 is a vaguely defined easement for electric "along the south road line of Morse Road, within the limits of the highway". No width given, but is believed to apply. Not plottable.

Item 12 - Instrument No. 201512300182286 applies and is as shown. This easement is Temporary Construction Easement and may have expired.

SEE SHEET 2 OF 2  
 FOR SURVEY DRAWING

**ALTA/NSPS LAND TITLE CERTIFICATION**

To: First American Title Insurance Company,  
 Ohio Real Title Agency, LLC,  
 Monica Morgan Whitehead,  
 The Stonehenge Company, Ohio Corporation.

This is to certify that this map or plat and the survey on which it is based were made in accordance with the 2021 Minimum Standard Detail Requirements for ALTA/NSPS Land Title Surveys, jointly established and adopted by ALTA and NSPS, and includes Items 2,3,4,6(Zoning reference only),8,11(a),14, and 16 of Table A thereof.

The field work was completed on February 02, 2022.

Kevin L. Baxter - Ohio Surveyor No. 7697 Date:

**SURVEYOR'S NOTES**

**MISCELLANEOUS NOTES:**  
 As used in this certification, to certify means to state a professional opinion of the conditions regarding those facts or findings which are the subject of the certification and does not constitute a guaranty or warranty, either expressed or implied.

Violations of zoning ordinances, restrictions or other rules and regulations are determined and enforced by the zoning and planning boards of the community in which the property is located.

The boundary lines of the subject property are contiguous to the property lines of its adjoiners with no gaps, gores or overlaps and is the same premises surveyed as described in the title commitment, Commitment No. 160567, as further referenced hereon.

The site has direct access to Morse Road a publicly accepted roadway.

The property is currently a vacant, wooded area.

At the time of the fieldwork, there was approximately 3-5 inches of snow cover. Some features of the site were/may have been covered and not visible to the surveyor.

**TABLE A NOTES:**  
 Item 16 - at the time of this survey, there was no observed surface evidence of earth moving work, building construction or additions.

**UTILITY NOTE**  
 The location, type and size of utilities and structures indicated on this survey drawing are a compilation of information furnished by the client, client representative, respective utility companies, field markings from locating services provided by the utility companies, and/or topographic data obtained at the time of our field survey. Utilities not marked in the field are labeled "per plan" on the survey and may be shown from information provided by the client, client representative, and/or respective utility companies, and not from an actual construction drawing. The location of facilities marked by an underground locating service are subject to a tolerance zone as specified by the Common Ground Alliance (CGA) Best Practices guidelines. As such, the utility locations indicated are not necessarily complete or correct, since existing utilities may not exist in the locations shown, and other utilities may exist that are not shown. Where additional or more detailed information is required, the client is advised that excavation may be necessary.

Field locating services, furnished by the utility companies, do not provide any depth of marked facilities.

Electric pedestals, electric transformers, lighting system, telephone closures, fire protection systems, power generators, irrigation systems, etc., may have been found during the field investigation. No field markings or utility drawings were provided to the surveyor depicting underground or overhead facilities that may connect to these facilities.

**ZONING:**  
 Property is Currently Zoned ER-1 (Estate Residential District) per City of Gahanna, Planning, Building and Zoning Division. See Zoning Codes for Restrictions not Shown.

**FLOOD INFORMATION:**  
 By graphic depiction only: The subject property is in Zone X (areas determined to be outside of the 0.2% annual chance floodplain) on Flood Insurance Rate Map, Panel 211 of 465, Franklin County, Ohio and Incorporated Areas, Map No. 39049C0211 K (Effective Date: June 17, 2008). No field work specific to determining this zone was performed. Subject to map scale uncertainty.

**POSSIBLE OBSERVED ENCROACHMENTS:**  
 None visible

**PARKING TABLE:**  
 The site is currently a vacant, wooded area with no marked parking spaces.

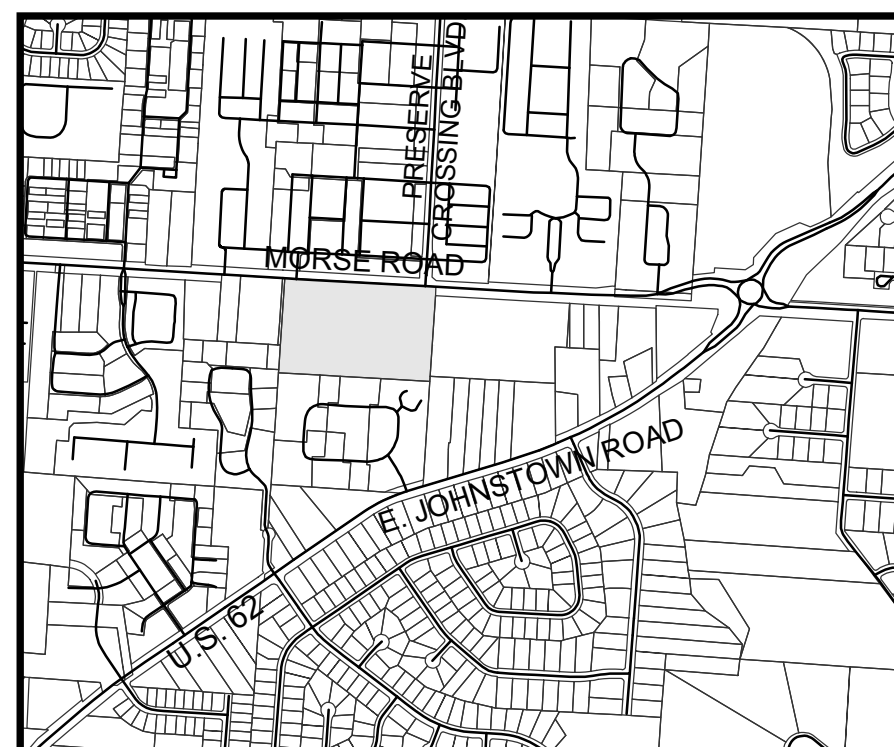

LOCATION MAP  
 NO SCALE

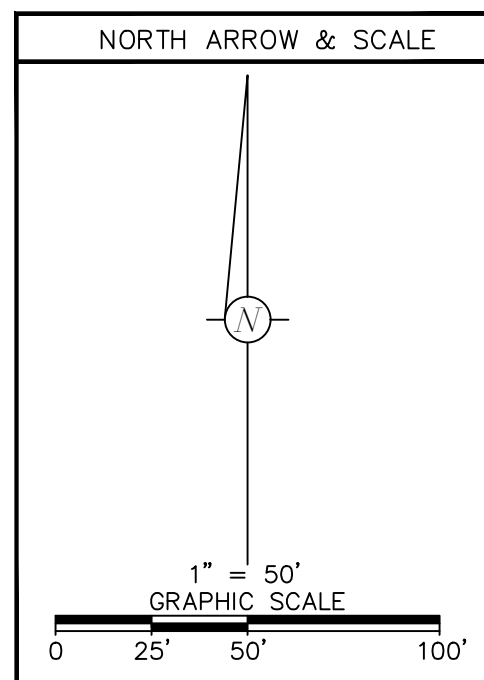

**ALTA LEGEND AND SYMBOLS**

**EXISTING SYMBOLS LEGEND**

Sign	STREET SIGN	C.C.	CABLE TELEVISION DROP
Area Light	AREA LIGHT	C.P.	CABLE TELEVISION PEDESTAL
Yard Light	YARD LIGHT	G.V.	GAS VALVE
Light Pole	LIGHT POLE	G.S.	GAS SERVICE
Light Pole W/SQR. BASE	LIGHT POLE W/SQR. BASE	G.M.	GAS METER
Light Pole W/RND. BASE	LIGHT POLE W/RND. BASE	G.	GAS MARKER
Electric Guy	ELECTRIC GUY	C.O.	CLEAN OUT
Electric Marker	ELECTRIC MARKER	Stm. CB TC 708.43	CATCH BASIN W/TOP OF CASTING ELEV.
Electric Transformer	ELECTRIC TRANSFORMER	Stm. Inlet TC 707.28	CURB INLET W/TOP OF CASTING ELEV.
Electric Meter	ELECTRIC METER	Stm. CB w/Underdrain	CATCH BASIN W/ UNDER DRAIN LINES
Electric Drop	ELECTRIC DROP	Stm. MH TC 708.43	STORM MANHOLE W/TOP OF CASTING ELEV.
Electric Pull Box	ELECTRIC PULL BOX	Stm. MH TC 708.43	SANITARY MANHOLE W/TOP OF CASTING ELEV.
Electric Pedestal	ELECTRIC PEDESTAL	D.S.	DOWN SPOUT
Electric Outlet	ELECTRIC OUTLET	R.D.	ROOF DRAIN
Telephone Closure	TELEPHONE CLOSURE	H.C.U.	HEATING/COOLING UNITS
Telephone Drop	TELEPHONE DROP	B.	BOLLARD
Telephone Pull Box	TELEPHONE PULL BOX	W.P.	WOOD POST
Telephone Pedestal	TELEPHONE PEDESTAL	M.P.	METAL POST
Telephone Pole	TELEPHONE POLE	M.B.	MAIL BOX
Utility Pole	UTILITY POLE	F.	FLAGPOLE
Pull Box	PULL BOX	G.	EXISTING GAS LINE
Traffic Pull Box	TRAFFIC PULL BOX	W.L.	EXISTING WATER LINE
Traffic Control Box	TRAFFIC CONTROL BOX	U.E.L.	EXISTING UNDERGROUND ELECTRIC LINE
Traffic Signal	TRAFFIC SIGNAL	O.E.L.	EXISTING OVERHEAD ELECTRIC LINE
Traffic Pole	TRAFFIC POLE	U.T.L.	EXISTING UNDERGROUND TELEPHONE LINE
Traffic Pole w/ Walk	TRAFFIC POLE W/ WALK	O.H.T.	EXISTING OVERHEAD TELEPHONE LINE
Water Valve	WATER VALVE	O.C.T.V.	EXISTING OVERHEAD CABLE TELEVISION LINE
Fire Hydrant	FIRE HYDRANT	S.	EXISTING UNDERGROUND CABLE TELEVISION LINE
Water Meter	WATER METER	I.C.	EXISTING INDEX CONTOUR
Water Service	WATER SERVICE	709	EXISTING INTERMEDIATE CONTOUR
Water Control Valve	WATER CONTROL VALVE	709	EXISTING FENCE LINE
Irrigation Control Valve	IRRIGATION CONTROL VALVE	3/4" I.D. Iron Pipe Set, 30" in length, w/Cap Stamped "BIRD & BULL, INC." Unless Otherwise Shown.	EXISTING GUARDRAIL

V3 Companies, Ltd.  
 Engineers and Surveyors  
 3500 Snouffer Road, Suite 225  
 Columbus, Ohio 43235  
 Ph: (614) 761-1661  
 Fax: (614) 761-1328  
 WWW.V3CO.COM



MONICA MORGAN WHITEHEAD  
 INSTR. NO. 200201080006868, INSTR. NO. 201405050054990

**ALTA/NSPS LAND TITLE SURVEY**  
 SOUTH SIDE OF MORSE ROAD AT PRESERVE  
 CROSSING BOULEVARD,  
 CITY OF GAHANNA, FRANKLIN CO., OHIO

14.005 AC. IN QTR. TWP. 2, T. 1 N., R. 16 W., U.S.M.L.  
 SCALE: 1" = 50'

DWN: KLB	CKD:	FEBRUARY 10, 2022	JOB NO. 211084	1
				2

N:\2021\211084\Drawings\ACAD\SV\211084 ALTA.dwg 03/21/2022

N:\2021\211084\Drawings\ACAD\SV\211084 ALTA.dwg 03/21/2022

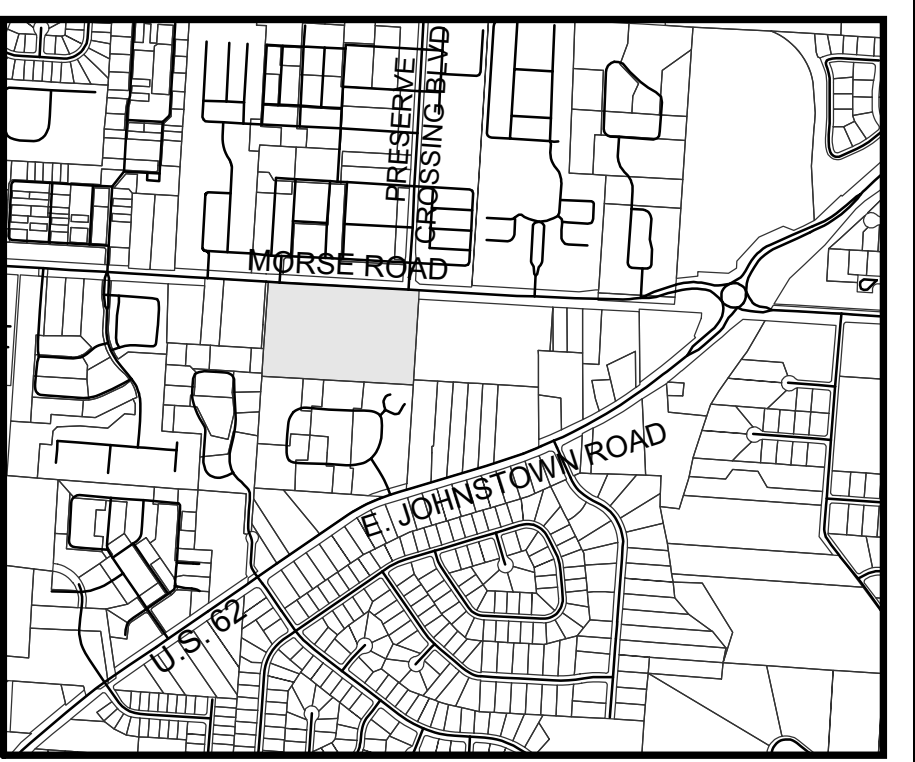
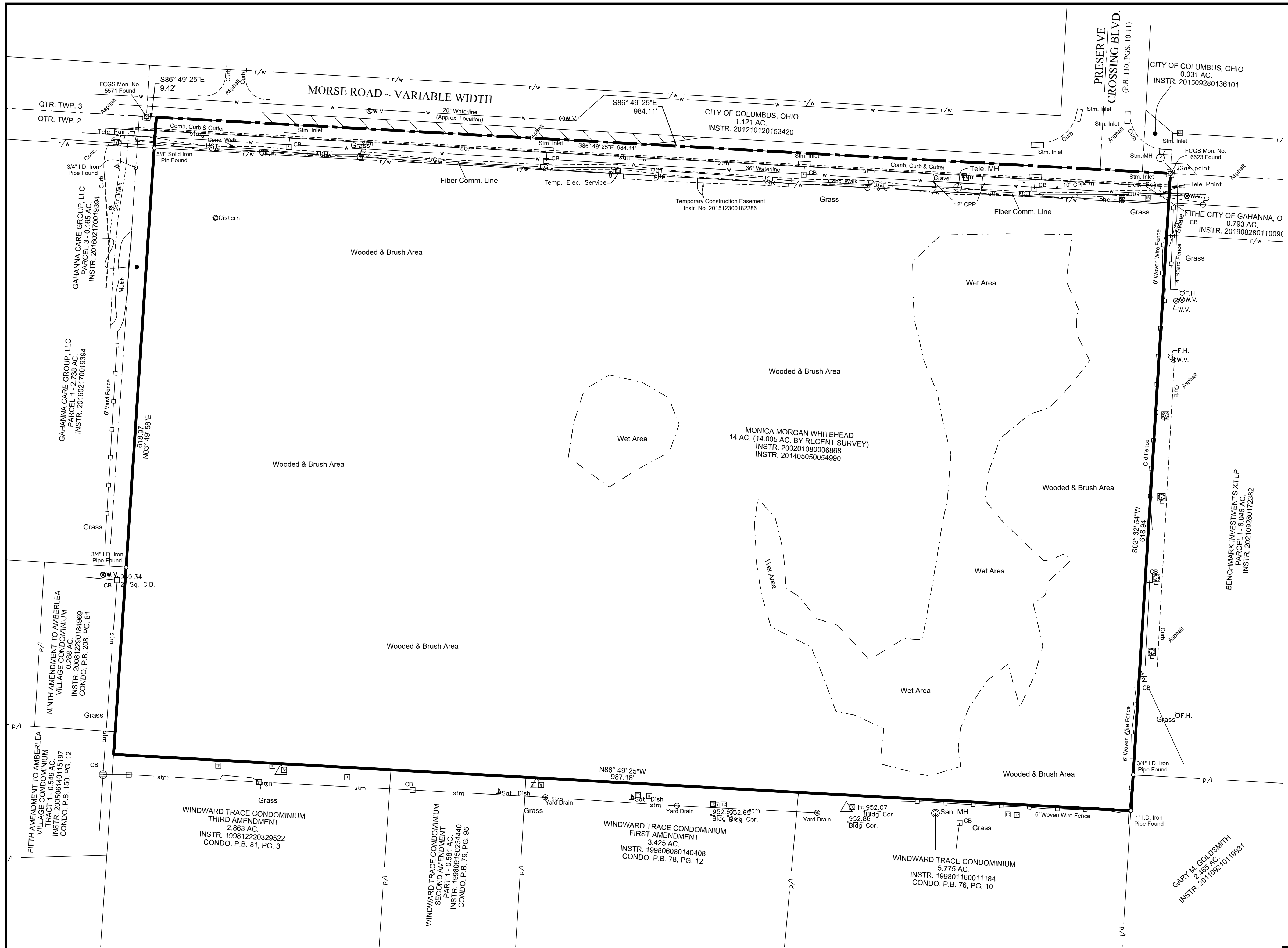

LOCATION MAP  
NO SCALE

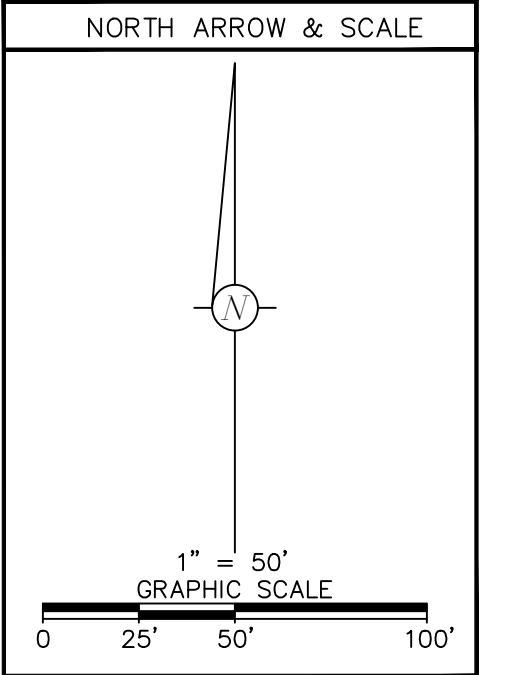

ALTA LEGEND AND SYMBOLS	
EXISTING SYMBOLS LEGEND	
Sign	SIGN
Street Sign	STREET SIGN
Area Light	AREA LIGHT
Yard Light	YARD LIGHT
Light Pole	LIGHT POLE
Light Pole W/SQR. BASE	LIGHT POLE W/SQR. BASE
Light Pole W/RND. BASE	LIGHT POLE W/RND. BASE
E.T.	ELECTRIC TRANSFORMER
E.M.	ELECTRIC METER
E.D.	ELECTRIC DROP
E.P.B.	ELECTRIC PULL BOX
E.O.	ELECTRIC OUTLET
E.P.	ELECTRIC PEDESTAL
E.O.U.	ELECTRIC OUTLET UNDER
T.D.	TELEPHONE DROP
T.P.B.	TELEPHONE PULL BOX
T.P.	TELEPHONE PEDESTAL
U.P.	UTILITY POLE
P.B.	PULL BOX
Traffic P.B.	TRAFFIC PULL BOX
Traffic C.B.	TRAFFIC CONTROL BOX
Traffic S.	TRAFFIC SIGNAL
T.P.	TRAFFIC POLE
T.P.W.	TRAFFIC POLE W/ WALK
Spr.	SPRINKLER
W.V.	WATER VALVE
F.H.	FIRE HYDRANT
M.	WATER METER
W.S.	WATER SERVICE
W.C.V.	WATER CONTROL VALVE
I.C.V.	IRRIGATION CONTROL VALVE
C.D.	CABLE TELEVISION DROP
C.T.P.	CABLE TELEVISION PEDESTAL
G.V.	GAS VALVE
G.S.	GAS SERVICE
G.M.	GAS METER
G.M.K.	GAS MARKER
C.O.	CLEAN OUT
Stm. Inlet	CATCH BASIN W/TOP OF CASTING ELEV.
Stm. Inlet	CATCH BASIN W/ UNDER DRAIN LINES
Stm. MH	STORM MANHOLE W/TOP OF CASTING ELEV.
San. MH	SANITARY MANHOLE W/TOP OF CASTING ELEV.
D.S.	DOWN SPOUT
R.D.	ROOF DRAIN
H.C.U.	HEATING/COOLING UNITS
B.	BOLLARD
W.P.	WOOD POST
M.P.	METAL POST
M.B.	MAIL BOX
F.	FLAGPOLE
E.G.L.	EXISTING GAS LINE
E.W.L.	EXISTING WATER LINE
E.U.E.L.	EXISTING UNDERGROUND ELECTRIC LINE
E.O.E.L.	EXISTING OVERHEAD ELECTRIC LINE
E.U.T.L.	EXISTING UNDERGROUND TELEPHONE LINE
E.O.T.L.	EXISTING OVERHEAD TELEPHONE LINE
E.U.C.T.L.	EXISTING UNDERGROUND CABLE TELEVISION LINE
E.O.C.T.L.	EXISTING OVERHEAD CABLE TELEVISION LINE
E.I.C.	EXISTING INDEX CONTOUR
E.I.C.	EXISTING INTERMEDIATE CONTOUR
E.F.L.	EXISTING FENCE LINE
E.G.	EXISTING GUARDRAIL
3/4" I.D. Iron Pipe	3/4" I.D. Iron Pipe Set, 30" in length, w/Cap Stamped "BIRD & BULL, INC." Unless Otherwise Shown.



V3 Companies, Ltd.  
Engineers and Surveyors  
3500 Snouffer Road, Suite 225  
Columbus, Ohio 43235  
Ph: (614) 761-1661  
Fax: (614) 761-1328  
WWW.V3CO.COM

MONICA MORGAN WHITEHEAD  
INSTR. NO. 200201080006868, INSTR. NO. 201405050054990

**ALTA/NSPS LAND TITLE SURVEY**  
SOUTH SIDE OF MORSE ROAD AT PRESERVE  
CROSSING BOULEVARD,  
CITY OF GAHANNA, FRANKLIN CO., OHIO

14.005 AC. IN QTR. TWP. 2, T. 1 N., R. 16 W., U.S.M.L.  
SCALE: 1" = 50'  
DWN: KLB CKD: FEBRUARY 10, 2022

JOB NO. 211084  
2



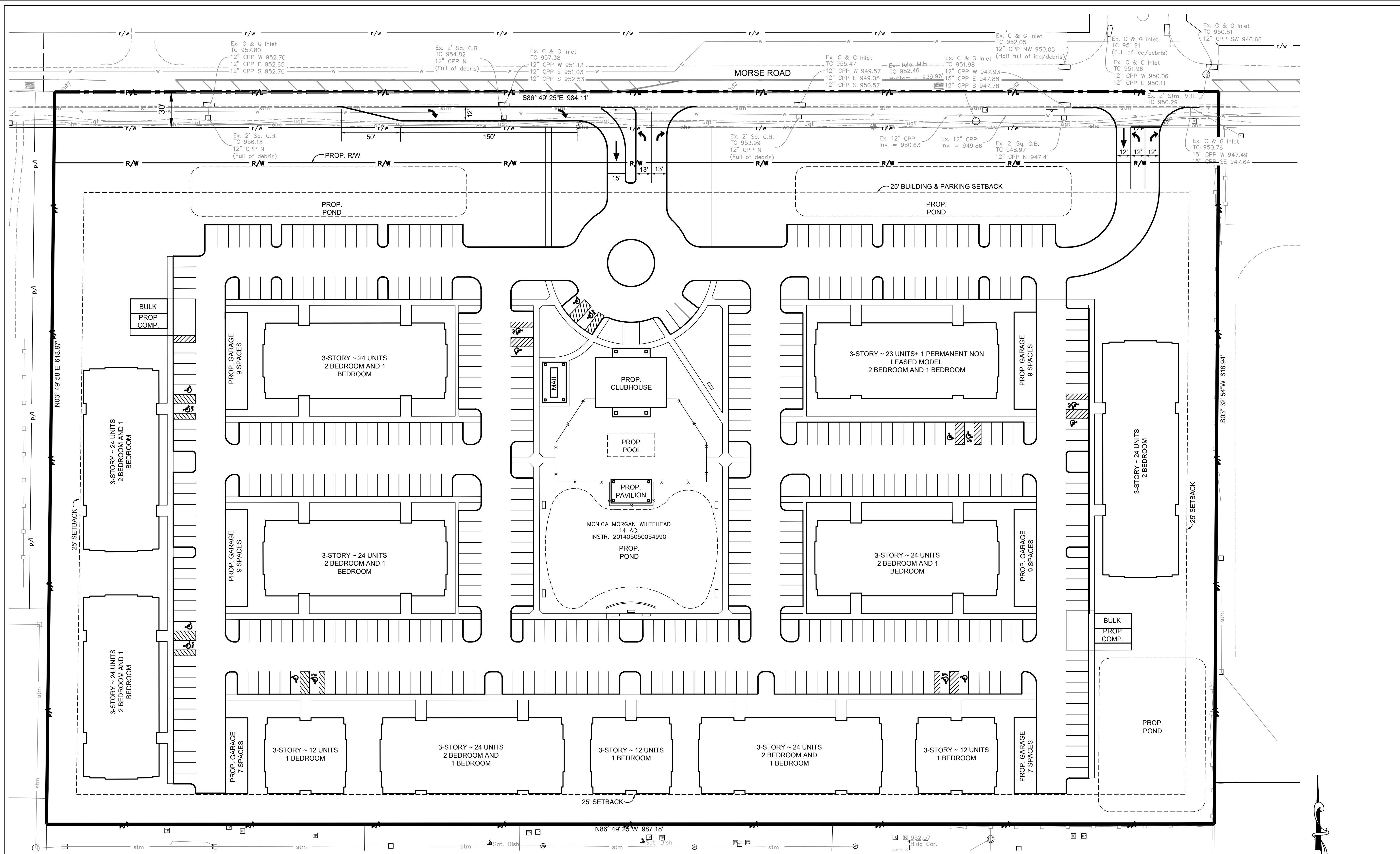

REVISIONS	
NO.	DESCRIPTION

PROJECT NO.: 211084	ORIGINAL ISSUE DATE: O/D/A/T/E
PROJECT MANAGER: AAG	NO. DATE
DESIGNED BY: AAG	DESCRIPTION
DRAWN BY: RJB	NO. DATE
OH	

**CONCEPT PLAN**  
**MORSE ROAD**  
 S03

COLUMBUS

3500 Snouffer Road,  
 Suite 225  
 Columbus, OH 43235  
 614.761.1661 phone  
 www.v3co.com

DRAWING NO.  
**1**

AREA	TOTAL PARKING PROVIDED	PARKING RATIO
UNCOVERED PARKING (251 UNITS)	454 SPACES (16 HANDICAP)	1.81 SPACES / UNIT
OUTDOOR GARAGE PARKING	50 SPACES	0.20 SPACES / UNIT
<b>TOTAL PARKING TARGET</b>	<b>XXX</b>	<b>X.XX SPACES / UNIT</b>
<b>TOTAL PARKING PROVIDED</b>	<b>504</b>	<b>2.05 SPACES / UNIT</b>

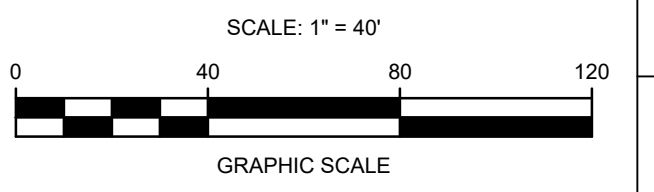

Statement per 1133.03 (b) of the Gahanna Zoning Code:

- (1) The proposed development is consistent with the comprehensive land use plan dated 2019 for the City of Gahanna. Residential uses are planned for this subarea.
- (2) The proposed development is compatible with the site's environmental features and is consistent with adjacent residential development.
- (3) The site is ideal for the type and density of development shown on the proposed development plan. Other vacant multifamily zoned sites are few in the City of Gahanna.
- (4) The proposed development is similar to the site across Morse Road which are multifamily. It is also consistent with developed sites from the East and South which are also multifamily.
- (5) The City's infrastructure can service this site without compromising the health, safety and welfare of its citizens.
- (6) The demand for multifamily housing is expanding. MORPC predicts that the Central Ohio population will increase by 634,000 individuals by 2050. Since 2010 70% of the population growth has occurred in Franklin County due to its proximity to jobs. To keep up with projected growth, the region is expected need nearly 270,000 additional housing units by 2050. Additionally, the announcement of the Intel investment in New Albany will only increase these numbers. The proposed multifamily development is in response to that demand. The units will be attractive and high quality, designed to appeal to individuals and households earning between \$100-150,000.

Harper Architectural Studio, LLC

Friday, April 15, 2022

Mr. Michael Blackford  
Director of Planning  
Department of Planning  
City of Gahanna  
200 S. Hamilton Road  
Gahanna, Ohio 43230

Re: Resubmission for Morse Road Multi-Family Development

Michael,

Please find with this letter a revised site plan for the rezoning application for the Morse Road multi family development. We have modified the site plan to accommodate 335 units which roughly equates to 24 units per acre. We have 13.96 acres, so the actual number would be under 24 units per acre. The rezoning would still be for the MFRD district.

With this plan we have a total of 467 parking spaces. We calculate the required spaces at 492 with 180 one bedroom units and 156 two bedroom units.

In response to Staff's comments received on March 4th, 2022 we provide the following commentary:

REZONING:

3. The setback on our revised plan reflects the setback of 25'-0".
4. We understand that the process will require a final development plan.
5. We understand the open space requirement and will provide this on the final development plan.
6. We understand that buffer zones will be required.
7. We understand the minimum requirement of 700 SF for one bedroom units. The one bedroom units will exceed this number.
8. We will prepare a letter to the Parks department that will explain why we feel fees-in-lieu are appropriate for this application.
9. The environmental assessment is submitted herein with this letter.

VARIANCE:

3. The revised site plan shows the required 25'-0" setback.
4. We will provide the letter requested for the variances.
5. We understand that review of the final development plan may require additional applications.
6. We will need a parking variance if the attached plan is the final development plan.
7. The lot width requirement cannot be attained. A variance will be required.
8. A variance will be required for the proposed densities.
9. The requirement of Chapter 1149.03(1)(5) cannot be met. A variance will be required.
- 10 We will prepare a letter to the Parks department that will explain why we feel fees-in-lieu are appropriate for this application.
11. We understand that Staff may find additional variances as they further review the application.

Harper Architectural Studio, LLC

CONDITIONAL USE:

2. We have provided a statement previously with regard to the project. If insufficient please provide an example of past statements as a guide.
3. In discussions with the City, it is our understanding that City planning department shall assist in determining the conditional use(s) required.

Thank you,

A handwritten signature in blue ink, appearing to be "Scott R. Harper", written over a horizontal line.

Scott R. Harper, AIA, NCARB  
SRH/p



August 4, 2022

Scott Harper  
424 A Beecher Rd  
Gahanna, OH 43230

RE: Project 5503 Morse Rd Zoning/Rezoning

Dear Scott Harper:

The following comments were generated from the review of the submitted plans and documents for the referenced project.

### **Fire District**

1. The fire division has no objections to Conditional Use, Rezoning, and Variance for the 5503 Morse Road Apartment Property. *(Informational Comment)*

### **Planning**

2. Informational Comment - Please be aware that the site plan review is informational as part of the rezoning review. If the rezoning is successful, then additional applications such as a final development plan (FDP) and design review (DR) application will be required prior to any tree removal/site clearing/etc.
3. Informational Comment - Chapter 1149.03(j) requires a minimum of 15% of the site to be usable open space. Open space may include pool and clubhouse areas but does not include buffers. Compliance with this requirement will be reviewed as part of the FDP submittal.
4. Informational Comment - Please be aware that buffers will be required along the east, south, and west property lines. Please review Chapters 1149.03 and 1167.20 buffer and landscaping requirements. Compliance with these requirements will be reviewed as part of the FDP and DR submittals.
5. Informational Comment - Chapter 1149.03(i) requires a minimum unit size of 700 square feet for one bedroom apartments. Compliance with this requirement will be reviewed as part of the FDP submittal.
6. Chapter 1109.08(b) requires land dedication as part of the rezoning application/process for multifamily projects. Please review Chapter 1109.08 for complete details on land dedication requirements and process. It appears roughly 3.49 acres of onsite land dedication will be required or fees-in-lieu. The determination of onsite land dedication or fees-in-lieu is determined by the Parks and Recreation Board and the Director of Parks and Recreation. Staff recommends discussing with the Director of Parks and Recreation (Stephanie Ferrell 614-342-4259) the preferred means of conveying land. Please be aware that Planning Commission must evaluate land dedication or fees-in-lieu as part of the rezoning process.

4/20/22 - No information provided. As a reminder, an appraisal needs to be completed and reviewed by staff if the City elects to pursue fee-in-lieu.



7/12/22 - Based on the appraised value of the land ( $\$700,000/13.96$  acres =  $\$50,143.27$  per acre), the limitation of 25% land dedication, and the projected population, the fees-in-lieu amount is  $\$175,000.01$  ( $50,143.27$  acre x 3.49 acres).

### **Development Engineer**

7. The feasibility of Roadway Infrastructure to serve this project will be further reviewed as part of a Final Development Plan application. Gahanna is currently coordinating a review of the provided Traffic Impact Study with the City of Columbus, who shares jurisdiction over Morse Road. Results of that joint review will be provided once available.  
*(Informational Comment)*
8. An existing 10" sanitary sewer was extended to the southern border of this parcel to provide sewer service. While the MRFD zoning district is consistent with the land uses envisioned by the designers of that sewer, the applicant will need to submit calculations demonstrating this sewer has capacity to service the development at the proposed density as part of the Final Development Plan application.  
*(Informational Comment)*
9. Note that water and sewer connection fees have been updated for 2022. *(Informational Comment)*

### **Parks**

10. No Comment Per Julie Predieri

If you have any comments or questions, please contact me at [kelly.wicker@gahanna.gov](mailto:kelly.wicker@gahanna.gov) or (614) 342-4025.

Sincerely,

Kelly Wicker  
Planning and Zoning Coordinator

## STAFF REPORT

### Summary

A rezoning, conditional use, and variance applications have been submitted in order to develop 13.96 acres with 251 multifamily units. The property is currently zoned Estate Residential (ER-1). ER-1 permits large lot single family development. The proposed rezoning designation is Multifamily Residential District (MFRD). MFRD permits multifamily development at a density up to 18 units per acre. The proposal is for 17.96 units an acre. A conceptual site plan has been submitted that depicts building location, parking, access, and other improvements. If approved, additional applications will be required to finalize these improvements. A final development plan (FDP) and design review (DR) application will be required prior to any construction activities. It should be noted that Planning Commission would issue a recommendation on the rezoning and approval/denial of the conditional use and variance applications.

The rezoning portion of the project is to allow multifamily development. The proposed density is just under the maximum amount allowed via a conditional use, 18 units an acre. Other recent multifamily projects have been at a similar or a higher density. Properties to the south are also zoned and developed with multifamily developed. Although not within Gahanna, the properties to the north are developed with multifamily. The properties to the west and east are both zoned Suburban Office and Institutional (SO) and developed with assisted living.

A companion application, conditional use, has also been filed. MFRD zoning is unique in that many development standards, such as building height and density, require conditional use approval. The following conditional uses have been requested:

1. 1149.02(a)(1) – Buildings containing more than 8 units.
  - a. The site plan depicts unit counts up to 24 units per building.
2. 1149.02(a)(2) – Two or more residential buildings on a lot.
  - a. The site plan depicts 11 residential buildings on a single lot.
3. 1149.02(a)(3) – Density between 6 and 18 units per acre.
  - a. 17.96 units an acre has been requested.
4. 1149.02(a)(4) – Buildings exceeding 2 full stories
  - a. Three story buildings are requested.
5. 1149.02(b) – Flexible arrangement of buildings
  - a. Variances are requested to some of the development standards of MFRD and the zoning code.
6. 1149.02(c) – Accessory use buildings
  - a. The development includes a clubhouse, pool, garages and other amenities that are common and highly desirable in multifamily development.

An additional application, variance, has been submitted with the following variance requests:

1. 1149.03(b)(1)/(2) – Lot width
  - a. The code requires approximately ½ mile of lot width in order to develop 251 units. The lot width of the property is just under 1,000’.
  - b. Staff does not object to the variance request. Similar variances have been granted for other multifamily projects. Additionally, staff does not believe granting the variance would create any adverse impacts. The project appears to meet setback requirements and open space requirements.
2. 1149.03(l)(5) – Parking setback from residential buildings
  - a. The code prohibits parking areas closer than 25’ to a front or rear of a building.
  - b. Staff does not object to the variance request. The code requirement is unique to MFRD. Staff is unclear as to the purpose of the code provision and does not anticipate any negative impacts if approved. Similar variances have been granted for other multifamily projects.
3. 1169.05(a) – Conditional use expiration
  - a. A zoning certificate, which is issued as part of the building permit process, can only be granted within one year of conditional use approval. The applicant is requesting two years within approval.
  - b. Staff recommended the variance be included as the rezoning process and other permitting requirements will undoubtedly take longer than one year.

Chapter 1109.08 of the zoning code requires parkland dedication or fees-in-lieu as part of the rezoning process for multifamily projects. The amount of parkland, or fees-in-lieu, depends on the projected population and size of the project. The maximum amount of land or fees is capped at 25% of the total number of acres. The Parks and Recreation Board, Director of Parks and Recreation, and the Planning and Zoning Administrator perform an evaluation and issues a recommendation as to whether to accept onsite land dedication or fees-in-lieu. An evaluation has been performed and the recommendation is for fees-in-lieu. Based on the appraisal submitted, the fees-in-lieu amount is \$175,000.01. It is the recommendation of staff and the Parks and Recreation Board to Planning Commission to accept fees-in-lieu of onsite land dedication.

#### Land Use Plan

The Comprehensive Land Use Plan designates the property Mixed Use. Properties to the east and west are also Mixed Use, while properties to the south are Medium Density Residential. Mixed Use recommends building heights up to 70’ and density up to 30 units an acre.

One of the recommendations of the Land Use Plan is for additional housing, specifically apartments. 90% of the City’s housing stock was constructed prior to 2000. Housing opportunities need to evolve to match the preferences of the market. Modern apartment projects typically have the amenities and features desired, and lacking, in our existing housing stock.

The Land Use Plan also has data and recommendations on parks and open space. Over 11% of the City is park/open space. This is more than industrial, commercial and mixed use combined. The City has approximately 2.5 times more parkland per 1,000 residents than the national average.

The Land Use Plan makes recommendations. It does not mandate a specific use or intensity. The land use plan also goes into detail about the age of existing residential, the lack of new residential, and the need for new residential.

### Rezoning

Planning Commission shall consider the following elements, among other criteria, when deciding the proposed change:

1. Consistency with the goals, policies and comprehensive land use plan of the City of Gahanna, including any corridor plans, or subarea plans.

*The proposed rezoning to MFRD is consistent with the recommendations of the land use plan.*

2. Compatibility of the site's physical, geological, hydrological, and other environmental features with the potential uses allowed in the proposed zoning district.
3. Evidence the applicant cannot receive a reasonable return in investment through developing the property with one of the uses permitted under the current zoning.

*Staff has fielded many calls over the years about developing property. Staff does not ever recall anyone seeking property zoned ER-1 or wanting to rezone to ER-1. Alternatively, the most common request is for property able to be developed for multifamily.*

4. Availability of sites elsewhere in the City that are already zoned for the proposed use.

*Staff is not aware of many, if any, properties that are zoned MFRD and available for development. The Land Use Plan identified that less than 5% of all residential properties are two multifamily.*

5. The compatibility of all the potential uses allowed in the proposed zoning district with the surrounding uses and zoning in terms of land suitability, impacts on the environment, density, nature of use, traffic impacts, aesthetics, infrastructure, and potential influence in the value of existing abutting lands or approved developments.
6. The capacity of City infrastructure and services to accommodate the uses permitted in the requested district without compromising the "health, safety, and welfare" of its citizens.
7. The apparent demand for the type of uses permitted in the requested zoning district in the City in relation to the amount of land in the City currently zoned to accommodate the demand.

*Most inquiries that staff receives for development opportunities are for residential. These inquiries typically don't result in a development application as the City has few opportunities for development. It is staff's opinion that demand is extremely high for residential and the availability of land is very limited.*

#### Conditional Use

Requests for a conditional use shall be approved if the following four conditions are met:

1. The proposed use is a conditional use of the zoning district and the applicable development standards established in this zoning ordinance are met.
2. The proposed development is in accord with the appropriate plans for the area.
3. The proposed development will not have undesirable effects on the surrounding area.
4. The proposed development will be in keeping with the existing land use character and physical development potential of the area.

#### Variance

Planning Commission shall not grant a variance unless it finds that all of the following conditions apply:

- a) There are special circumstances or conditions applying to the land, building or use referred to in the application.
- b) The granting of the variance is necessary for the preservation and enjoyment of substantial property rights.
- c) The granting of the application will not materially affect adversely the health or safety of persons residing or working in the neighborhood of the proposed use and will not be materially detrimental to the public welfare or injurious to property or improvements in such neighborhood.

#### Recommendation

Staff recommends approval of all three applications as submitted and the fees-in-lieu of onsite parkland dedication. The zoning and density of the project is consistent with the recommendations of the land use plan. The requested conditional uses and variances are consistent with other recently approved requests. Additionally, it is staff's opinion that MFRD is the most appropriate zoning classification for the property. It's the same/similar zoning as other properties adjacent and in the vicinity to the property.

Location/Zoning Map

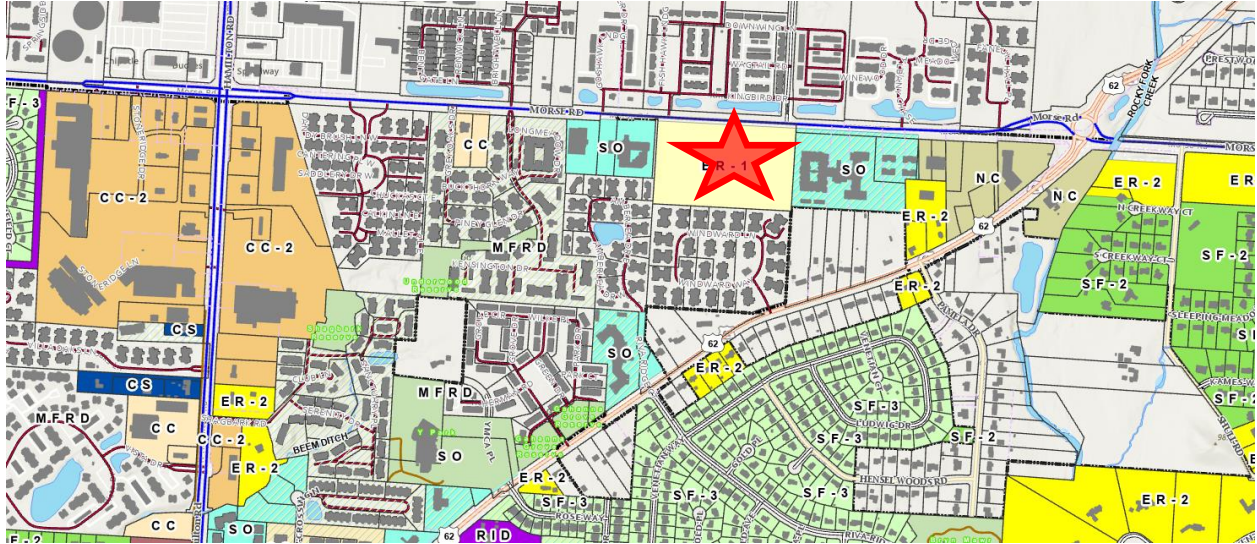

Respectfully Submitted By:  
Michael Blackford, AICP  
Director of Planning