



CITY OF GAHANNA

DEPARTMENT OF PUBLIC SERVICE AND ENGINEERING

ZONING DIVISION
200 S. Hamilton Road
Gahanna, Ohio 43230
614-342-4025
zoning@gahanna.gov
www.gahanna.gov

FINAL DEVELOPMENT PLAN APPLICATION

PLEASE NOTE: This application is not to be considered complete until all documents are received and approved by the Planning & Zoning Administrator.

| | | | |
|---|------------------------|--|--|
| Project/Property Address or Location: Southpark/ 1041 Enterprise Drive, Gahanna Oh | | Project Name/Business Name (if applicable): Southpark/ Geiger Excavating, Inc | |
| Parcel ID No.(s): 025-006164, 025-013680, 025-006160 | Current Zoning: OCT | Total Acreage: 28.53 | |
| Project Description: Proposed recycling facility with office/maintenance building. The facility includes outdoor storage, material processing, scales and equipment. The building consists of a single story steel frame approximately 7,425 sf. | | | |
| APPLICANT Name (primary contact) -do <u>not</u> use a business name: Steve Geiger | | Applicant Address: 1041 Enterprise Dr, Gahanna, Oh 43230 | |
| Applicant E-mail: geigerexcavating.steve@aol.com | | Applicant Phone No.: (614) 373-7526 | |
| BUSINESS Name (if applicable): Geiger Excavating, Inc | | | |
| ATTORNEY/AGENT Name: CARL ARTHUR | | Attorney/Agent Address: 250 OLD WILSON BRIDGE RD, SUITE 250 WORTHINGTON OH 43085 | |
| Attorney/Agent E-Mail: CARTHUR@CECINC.COM | | Attorney/Agent Phone No.: 614-468-6201 | |
| ADDITIONAL CONTACTS (please list all applicable contacts) | | | |
| Name(s): | | Contact Information (phone no./email): | |
| Contractor | | Civil & Environmental Consultants, Inc | |
| Developer | | 250 Old Wilson Bridge Rd, St 250 Worthington, Oh 43085 | |
| Architect | | 614-468-6201 Carl Arthur | |
| PROPERTY OWNER Name: (if different from Applicant) | | Property Owner Contact Information (phone no./email): | |

APPLICANT SIGNATURE BELOW CONFIRMS THE SUBMISSION REQUIREMENTS HAVE BEEN COMPLETED (see page 2)

I certify that the information on this application is complete and accurate to the best of my knowledge, and that the project as described, if approved, will be completed in accordance with the conditions and terms of that approval.

Applicant Signature: Steve Geiger Date: 7/24/18

THIS FORM IS AVAILABLE TO BE SUBMITTED ONLINE: www.gahanna.gov

INTERNAL USE

Zoning File No. FDP-185-2018
PC Meeting Date: _____
PC File No. _____

RECEIVED: KAW
DATE: 7-27-18

PAID: 500.00
DATE: 7-27-18
CHECK#: 4393



CITY OF GAHANNA

DEPARTMENT OF PUBLIC SERVICE AND ENGINEERING

ZONING DIVISION
 200 S. Hamilton Road
 Gahanna, Ohio 43230
 614-342-4025
 zoning@gahanna.gov
 www.gahanna.gov

FINAL DEVELOPMENT PLAN APPLICATION – SUBMISSION REQUIREMENTS

PLEASE NOTE: This application is not to be considered complete until all documents are received and approved by the Planning & Zoning Administrator.

| STAFF USE - INTAKE | TO BE COMPLETED/SUBMITTED BY THE APPLICANT: | APPLICANT | | STAFF USE | |
|---|---|-----------|-----|-----------|-----|
| | | YES | N/A | YES | N/A |
| | 1. Review Gahanna Code Section 1108 (visit www.municode.com) & Chapter 914 , Tree Requirements | ✓ | | | |
| | 2. Review the State of Ohio Fire Code Fire Service Requirements | ✓ | | | |
| | 3. Pre-application conference with staff | ✓ | | | |
| FINAL DEVELOPMENT PLAN shall contain the following: | | | | | |
| | 4. Scale: Minimum - one inch equals 100 feet. | ✓ | | | |
| | 5. The proposed name of the development, approximate total acreage, north arrow, and date | ✓ | | | |
| | 6. The names of any public and/or private streets adjacent to or within the development | ✓ | | | |
| | 7. Names and addresses of owners, developers and the surveyor who designed the plan | ✓ | | | |
| | 8. Vicinity map showing relationship to surrounding development and its location within the community | ✓ | | | |
| | 9. Natural features currently within proposed development, including drainage channels, tree lines, bodies of water, and other significant features | ✓ | | | |
| | 10. Current zoning district, building and parking setbacks | ✓ | | | |
| | 11. Proposed location, size and height of building and/or structures | ✓ | | | |
| | 12. Proposed driveway dimensions and access points | ✓ | | | |
| | 13. Proposed parking and number of parking spaces | ✓ | | | |
| | 14. Distance between buildings | ✓ | | | |
| | 15. Any other information the Planning Commission may deem to be necessary to evaluate the application. These items can include such things as elevations, traffic studies, floor plans, etc. | | ✓ | | |
| THE DEVELOPER SHALL SUBMIT A TABLE OF DEVELOPMENT CALCULATIONS. TABLE SHALL INCLUDE: | | | | | |
| | 16. Parking calculations: (square footage of proposed buildings, number of spaces per square foot, number of spaces required, and actual number of spaces proposed) | ✓ | | | |
| | 17. Lot coverage calculations: (square footage of site, area of permanently impervious surfaces broken down into buildings and parking, area of uncovered land, coverage requirements, proposed lot coverage) | ✓ | | | |
| | 18. Setback calculations, (if needed) | | ✓ | | |
| | 19. Landscaping calculations: (square footage of pavement, proposed area of landscaping, square footage of landscaping, number of two-inch caliper trees required, and number of trees proposed) | | | | |
| | 20. List of contiguous property owners & their mailing address | ✓ | | | |
| | 21. Pre-printed mailing labels for all contiguous property owners | ✓ | | | |
| | 22. Application fee (in accordance with the Building & Zoning Fee Schedule) | ✓ | | | |
| | 23. Application & all supporting documents submitted in digital format | ✓ | | | |
| | 24. Application & all supporting documents submitted in hardcopy format | ✓ | | | |
| | 25. Authorization Consent Form Complete & Notarized (see page 3) | ✓ | | | |

THIS FORM IS AVAILABLE TO BE SUBMITTED ONLINE: www.gahanna.gov

APPLICATION ACCEPTANCE

INTERNAL USE

This application has been reviewed and is considered complete and is hereby accepted by the Zoning Division of the City of Gahanna and shall be forwarded to the City of Gahanna Planning Commission for consideration.

Planning & Zoning Administrator Signature: _____

Date: _____

9/26/18

(Designer)

AUTHORIZATION CONSENT FORM

(must sign in the presence of a notary)

If you are filling out more than one application for the same project & address, you may submit a copy of this form with additional applications.

AUTHORIZATION FOR OWNER'S APPLICANT OR REPRESENTATIVE(S) *If the applicant is not the property owner, this section must be completed & notarized.*

I, STEVE GEIGER, the owner or authorized owner's representative of the subject property listed on this application, hereby authorize CEC to act as my applicant or representative(s) in all matters pertaining to the processing and approval of this application, including modifying the project. I agree to be bound by all terms and agreements made by the designated representative.

Property Owner Signature: *Steve M. Geiger Pres* Date: 6/22/18

AUTHORIZATION TO VISIT THE PROPERTY

I, STEVE GEIGER, the owner or authorized owner's representative of the subject property listed on this application, hereby authorize City representatives to visit, photograph and post notice (if applicable) on the property as described in this application.

Property Owner Signature: *Steve M. Geiger Pres* Date: 6/22/18

NOTARY

Subscribed and sworn to before me on this JUNE day of JUNE

State of Ohio County of Franklin

Notary Public Signature: *Brittney Stewart*



BRITTNEY STEWART
 Notary Public, State of Ohio
 My Commission Expires 08-07-2021

AGREEMENT TO COMPLY AS APPROVED

I, STEVE GEIGER, the applicant of the subject property listed on this application, hereby agree that the project will be completed as approved and any proposed changes to the approved plans shall be submitted for review and approval to the Zoning Division staff.

Applicant Signature: *Steve M. Geiger Pres* Date: 6/22/18

NOTARY

Subscribed and sworn to before me on this 22 day of JUNE

State of Ohio County of Franklin

Notary Public Signature: *Brittney Stewart*



BRITTNEY STEWART
 Notary Public, State of Ohio
 My Commission Expires 08-07-2021

FINAL DEVELOPMENT PLAN GEIGER EXCAVATION INC. SOUTHPARK

CITY OF GAHANNA, COUNTY OF FRANKLIN, STATE OF OHIO
JUNE 2018

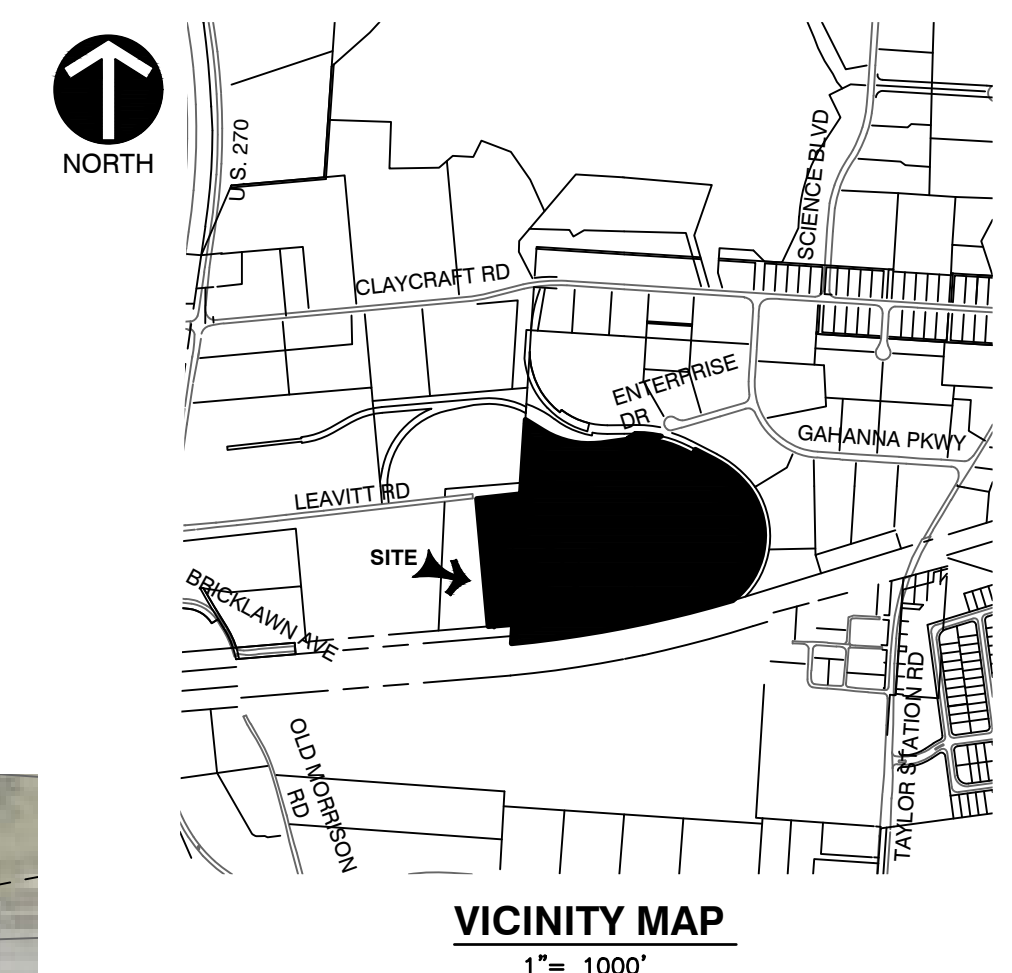
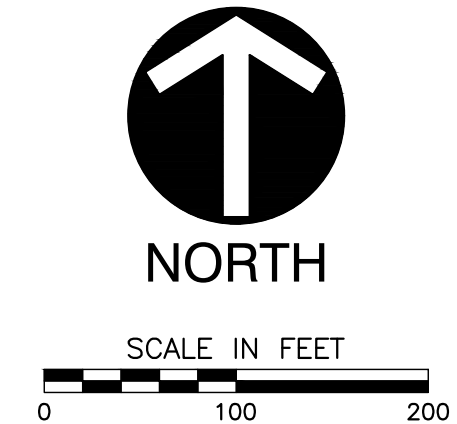

LEGEND

| | |
|--|---------------------------|
| | EXISTING SANITARY |
| | EXISTING SANITARY MANHOLE |
| | EXISTING STORM |
| | EXISTING STORM MANHOLE |
| | EXISTING CURB INLET |
| | EXISTING WATER |
| | EXISTING FIRE HYDRANT |
| | EXISTING STREAM |
| | EXISTING FLOODPLAIN |
| | PROPERTY LINE |
| | RIGHT-OF-WAY |
| | PROPOSED SANITARY SERVICE |
| | PROPOSED WATER SERVICE |
| | PROPOSED STORM |
| | PROPOSED CATCH BASIN |



SITE STATISTICS

| | |
|---------------------------|---|
| TOTAL ACREAGE | ±28.90 AC |
| ZONING | OFFICE, COMMERCIAL & TECHNOLOGY DIST (OCT) |
| BUILDING SETBACKS | |
| FRONT YARD | 75 FT |
| SIDE YARD | 25 FT |
| REAR YARD | 30 FT |
| PARKING SETBACKS | |
| PUBLIC RIGHT-OF-WAYS | 45 FT |
| SIDE AND REAR SETBACKS | 10 FT |
| SQUARE FOOTAGE OF SITE | 1,258,884 FT ² |
| PERVIOUS AREA | 1,232,601 FT ² |
| BUILDING | 7,425 FT ² |
| PARKING/DRIVES | 46,018 FT ² |
| SIDEWALK | 80 FT ² |
| IMPERVIOUS AREA | 53,503 FT ² |
| PARKING DATA | |
| BUILDING SQUARE FOOTAGE | 7,425 FT ² |
| BUILDING HEIGHT | 32' |
| NUMBER OF SPACES REQUIRED | 8 (7,425FT ² /1000FT ² PER SPACE) |
| NUMBER OF SPACES PROVIDED | 8 (1 HANDICAP) |

- REFERENCES**
- EXISTING BOUNDARY AND TOPOGRAPHIC INFORMATION IS PER SURVEY PERFORMED BY CIVIL & ENVIRONMENTAL CONSULTANTS INC. ON 6/4/2018
 - AERIAL PHOTOGRAPHY PROVIDED BY USGS EARTHSTAR GEOGRAPHICS SIO COPYRIGHT 2017 MICROSOFT CORPORATION, IMAGE DATE JUNE 2018

OWNER/DEVELOPER
GEIGER EXCAVATING, INC
1041 ENTERPRISE DRIVE
GAHANNA, OHIO 43230
PHONE: (614) 206-2617

ENGINEER/SURVEYOR
CIVIL & ENVIRONMENTAL CONSULTANTS, INC.
250 OLD WILSON BRIDGE ROAD, SUITE 250
WORTHINGTON, OHIO 43085
PHONE: (614) 540-6633
CONTACT: BRIAN BURKHART
EMAIL: BBURKHART@CECINC.COM

REVISION RECORD

| NO | DATE | DESCRIPTION |
|----|------|-------------|
| | | |
| | | |

CEC
Civil & Environmental Consultants, Inc.
250 Old Wilson Bridge Road · Suite 250 · Worthington, OH 43085
614-540-6633 · 888-598-6808
www.cecinc.com

GEIGER EXCAVATING, INC
CITY OF GAHANNA
FRANKLIN COUNTY, OHIO

FINAL DEVELOPMENT PLAN

| | | | |
|-------------|-----------|--------------|-----|
| DATE: | JUNE 2018 | DRAWN BY: | NSA |
| DWG SCALE: | | CHECKED BY: | CJA |
| PROJECT NO: | 180-632 | APPROVED BY: | |

DRAWING NO.: **C000**

SHEET 1 OF 1

P:\2018\180-632-C000\Drawings\180632-C001-Cover_Sheet.dwg(000) LS(9/11/2018 - central) - LP: 9/25/2018 1:43 PM

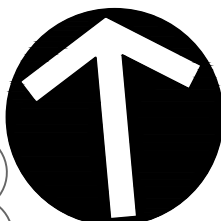

NORTH

SCALE IN FEET

0 60 120

GENERAL LANDSCAPE NOTES:

1. ALL CONSTRUCTION METHODS AND MATERIALS MUST CONFORM TO CURRENT STANDARDS AND SPECIFICATIONS OF THE FEDERAL, STATE, COUNTY, CITY, OR LOCAL REQUIREMENTS, WHICHEVER HAS JURISDICTION.
2. THE CONTRACTOR SHALL VERIFY ALL DIMENSIONS AND ELEVATIONS IN THE FIELD PRIOR TO THE START OF CONSTRUCTION. THE CONTRACTOR SHALL BE RESPONSIBLE FOR ALL FIELD DIMENSIONS AND ELEVATIONS DURING THE ENTIRE CONSTRUCTION SCHEDULE. IF ANY DISCREPANCIES ARE FOUND IN THESE PLANS FROM ACTUAL FIELD DIMENSIONS, THE CONTRACTOR SHALL CONTACT THE ENGINEER IMMEDIATELY.
3. CONTRACTOR SHALL MAINTAIN ONE SET OF AS-BUILT/RECORD DRAWINGS ON THE JOB SITE DURING CONSTRUCTION FOR DISTRIBUTION TO THE OWNER AND/OR OWNER'S REPRESENTATIVE UPON COMPLETION.
4. NO CHANGES TO THE SITE LANDSCAPE LAYOUT ARE ALLOWED WITHOUT THE WRITTEN APPROVAL OF THE ENGINEER.
5. CONTRACTOR SHALL SUPPLY ALL PLANT MATERIALS IN QUALITY AND QUANTITIES SUFFICIENT TO COMPLETE THE PLANTING AS SHOWN ON DRAWINGS.
6. ALL MATERIAL SHALL CONFORM TO THE GUIDELINES ESTABLISHED BY THE CURRENT "AMERICAN ASSOCIATION OF NURSERY STOCK, ANSI Z60.1-2004", PUBLISHED BY THE AMERICAN ASSOCIATION OF NURSERYMAN.
7. NO PLANT SHALL BE PUT INTO THE GROUND BEFORE ROUGH GRADING HAS BEEN FINISHED AND APPROVED.
8. ALL PLANTS SHALL BE PLANTED SO THAT THE ROOT CROWN IS PLANTED AT GRADE LEVEL.
9. ALL PLANTS SHALL BE BALLED AND WRAPPED OR CONTAINER GROWN AS SPECIFIED. NO CONTAINER GROWN STOCK WILL BE ACCEPTED IF IT IS ROOT BOUND. ALL ROOT WRAPPING MATERIAL MADE OF SYNTHETICS OR PLASTICS SHALL BE REMOVED AT THE TIME OF PLANTING. TWINE OR ROPE SHALL BE REMOVED FROM AROUND CROWN OF TRUNK TO PREVENT GIRDLING OF TREE OR SHRUB.
10. WITH CONTAINER GROWN STOCK, THE CONTAINER SHALL BE REMOVED AND THE CONTAINER BALL SHALL BE CUT THROUGH THE SURFACE IN TWO VERTICAL LOCATIONS.
11. THE DAY PRIOR TO PLANTING, THE LOCATIONS OF ALL TREES AND SHRUBS SHALL BE STAKED FOR APPROVAL BY OWNER(S).
12. THE LANDSCAPE CONTRACTOR SHALL REFER TO CONTRACT SPECIFICATIONS FOR ADDITIONAL REQUIREMENTS.
13. THE LANDSCAPE CONTRACTOR SHALL GUARANTEE NEW PLANT MATERIAL THROUGH ONE (1) CALENDAR YEAR FROM THE TIME OF SUBSTANTIAL COMPLETION OF PROJECT.
14. IF THERE IS A DISCREPANCY BETWEEN THE PLANS AND THE PLANT SCHEDULE, THE PLANS SHALL TAKE PRECEDENCE.
15. CONTRACTOR SHALL REPAIR ANY DAMAGE TO PROPERTY FROM PLANTING OPERATIONS AT NO COST TO OWNER.
16. STAKES AND OR GUY WIRES SHALL BE REMOVED AFTER ONE (1) YEAR OF INSTALLATION.
17. ALL EXISTING LANDSCAPING SHALL BE MAINTAINED DURING CONSTRUCTION. ANY MATERIAL DEEMED DEAD OR UNSATISFACTORY BY LANDSCAPE ARCHITECT, WILL BE REPLACED EQUIVALENT IN SIZE AND SHAPE AT NO COST TO OWNER.
18. IF PLANT SPECIES SPECIFIED ARE FOUND TO BE UNAVAILABLE OR NOT IN SUFFICIENT QUANTITIES AT TIME OF PLANTING, THE CONTRACTOR MAY SUBSTITUTE SPECIES UPON WRITTEN APPROVAL BY LANDSCAPE ARCHITECT.

| | | | |
|--------|---------------------------------|----|----------------|
| SYMBOL | DESCRIPTION | 1 | PLANT QUANTITY |
| | | AG | PLANT TYPE |
| | | PR | REQ. LOCATION |
| FN | FOUNDATION PLANTINGS | | |
| IN | INTERIOR LOT REQUIRED PLANTINGS | | |
| PR | IMPERVIOUS REQUIRED PLANTINGS | | |

'IN'- INTERIOR PARKING LOT PLANTING TABLE'

(MIN 5% OF INTERIOR PARKING AREA TO HAVE LANDSCAPE AREA)
(1 SHADE TREE (3" MIN. CAL. IN. SIZE) FOR EVERY 100 SQ. FT. OF REQUIRED LANDSCAPE AREA)

| SYMBOL | INTERIOR PARKING AREA | LANDSCAPE AREA REQUIRED | LANDSCAPE AREA PROVIDED | TREES REQUIRED | TREES PROVIDED |
|--------|-----------------------|-------------------------|-------------------------|----------------|----------------|
| | 1,680 SQ. FT. | 84 SQ. FT. | 327 SQ. FT. | 0.84 | 2 |

'PR'- IMPERVIOUS PAVEMENT PLANTING TABLE'

(1" CAL. SHADE TREE FOR EVERY 1000 SQ. FT. OF IMPERVIOUS AREA)

| SYMBOL | IMPERVIOUS AREA | TREE INCHES REQUIRED | TREE INCHES PROVIDED |
|--------|-----------------|----------------------|--------------------------------|
| | 53,300 SQ. FT. | 53.3" | 55" (22- 2-1/2" CAL. TREES) |

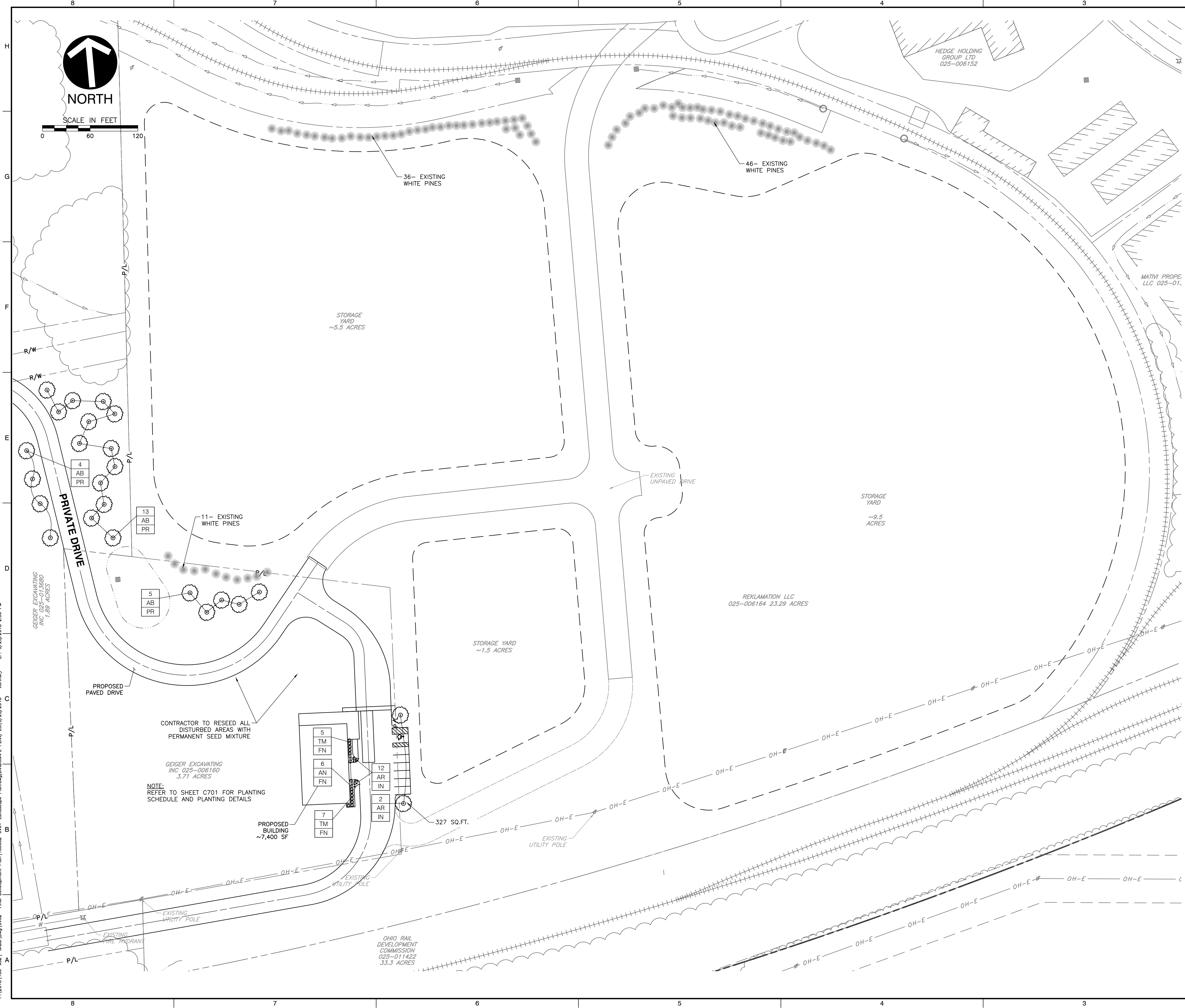

| NO | DATE | REVISION RECORD | DESCRIPTION |
|----|------|-----------------|-------------|
| | | | |
| | | | |

C&E
Civil & Environmental Consultants, Inc.
 250 Old Wilson Bridge Road · Suite 250 · Worthington, OH 43085
 614-540-6633 · 888-598-6808
 www.ccecinc.com

GEIGER EXCAVATING, INC
CITY OF GAHANNA
FRANKLIN COUNTY, OHIO

SITE LANDSCAPE PLAN

DATE: JUNE 2018 DRAWN BY: NSA
 DWG SCALE: 1"=60' CHECKED BY: CJA
 PROJECT NO: 180-832
 APPROVED BY:

DRAWING NO.: **C700**
 SHEET 7 OF 1

A:\2018\180-832-C700-02- Final Development Plan\180-832-C700-Landscape Plan.dwg (LANDSCAPE PLAN) LSC/25/2018 - cont'd - LP: 8/25/2018 2:59 PM

A:\2018\180-632-CAD\DWG\CAD2- Final Development Plan\180-632-CAD2-Landscape Plan.dwg(LANDSCAPE PLAN (2)) (LS) (9/25/2018 2:51 PM) - Lp: 9/25/2018 2:51 PM

| COURTYARD PLANTING SCHEDULE | | | | | | | |
|-----------------------------|-----|-----|---|-------------------------------|----------------------|--------------------|--------------------|
| LEGEND | KEY | QTY | BOTANICAL NAME | COMMON NAME | SIZE | REMARKS | HEIGHT AT MATURITY |
| | | | | | CROWN | | SPREAD AT MATURITY |
| ⊕ | AB | 2 | Acer rubrum 'Burgundy Belle' | Burgundy Belle Red Maple | 2-1/2' Cal. B & B | Deciduous Tree | 15-20' |
| ⊕ | AR | 2 | Acer rubrum 'Red Sunset' | Red 'Sunset' Red Maple | 3' Cal. B & B | Deciduous Tree | 40-50' |
| ⊙ | AN | 6 | Aronia melanocarpa 'Iroquois Beauty' | Iroquois Beauty Chokeberry | 24" No. 9 Cont. | Deciduous Shrub | 5'-4' 4'-5' |
| ● | NF | 12 | Nepeta x foassenii 'Blue Wonder' | Blue Wonder Catmint | 12" No. 1 Cont. | Perennial | 18" |
| ☀ | TM | 12 | Taxus x media 'Densiformis' | Densi Yew | 24" No. 5 Cont. | Evergreen Shrub | 4'-5' 4'-5' |

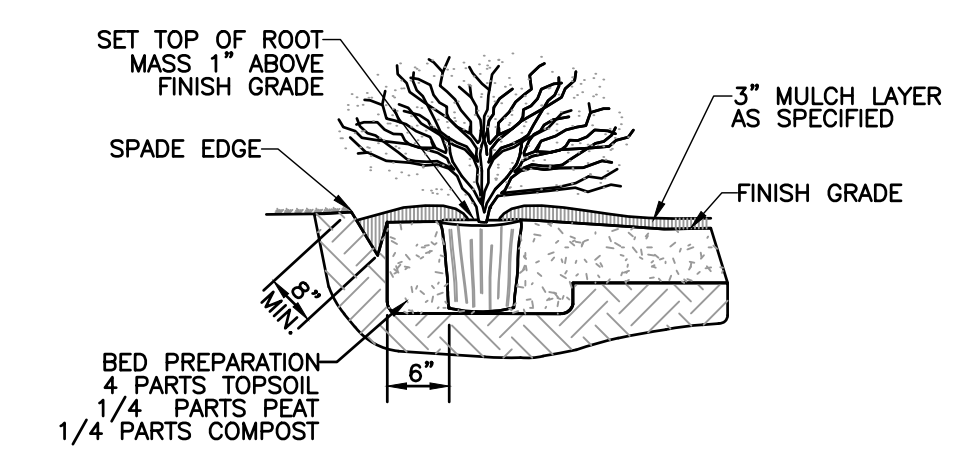
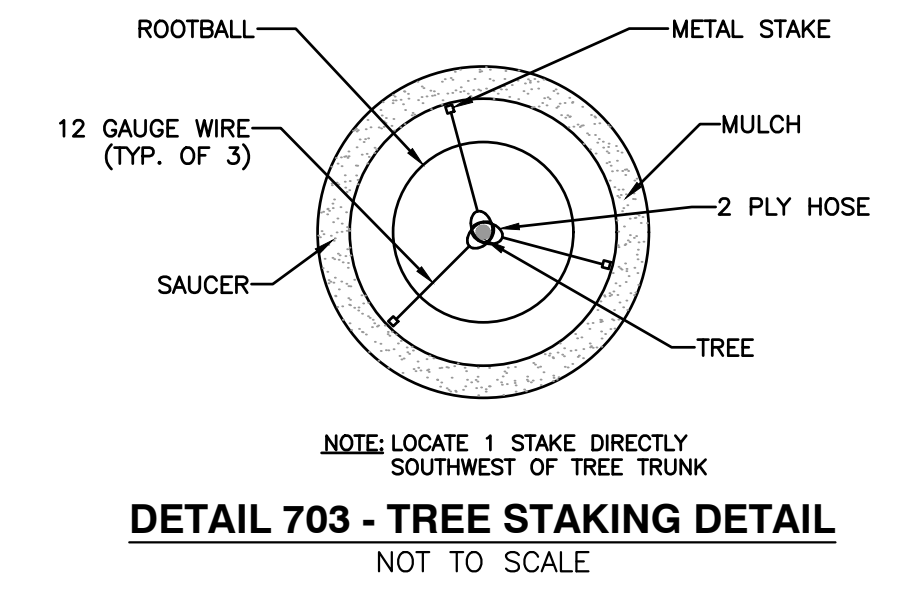

DETAIL 702 - SHRUB/ SMALL TREE PLANTING DETAIL
NOT TO SCALE

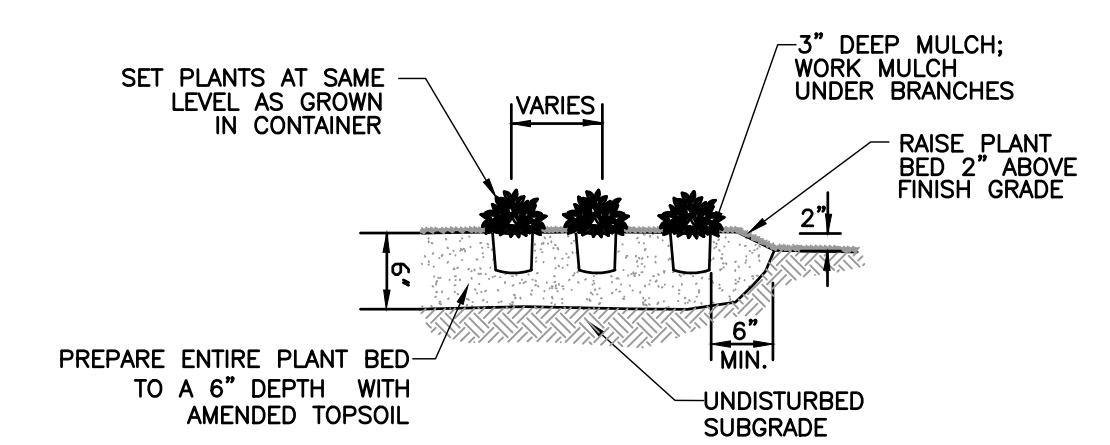

DETAIL 701 - ORNAMENTAL GRASS/ PERENNIAL AND GROUNDCOVER PLANTING DETAIL
NOT TO SCALE

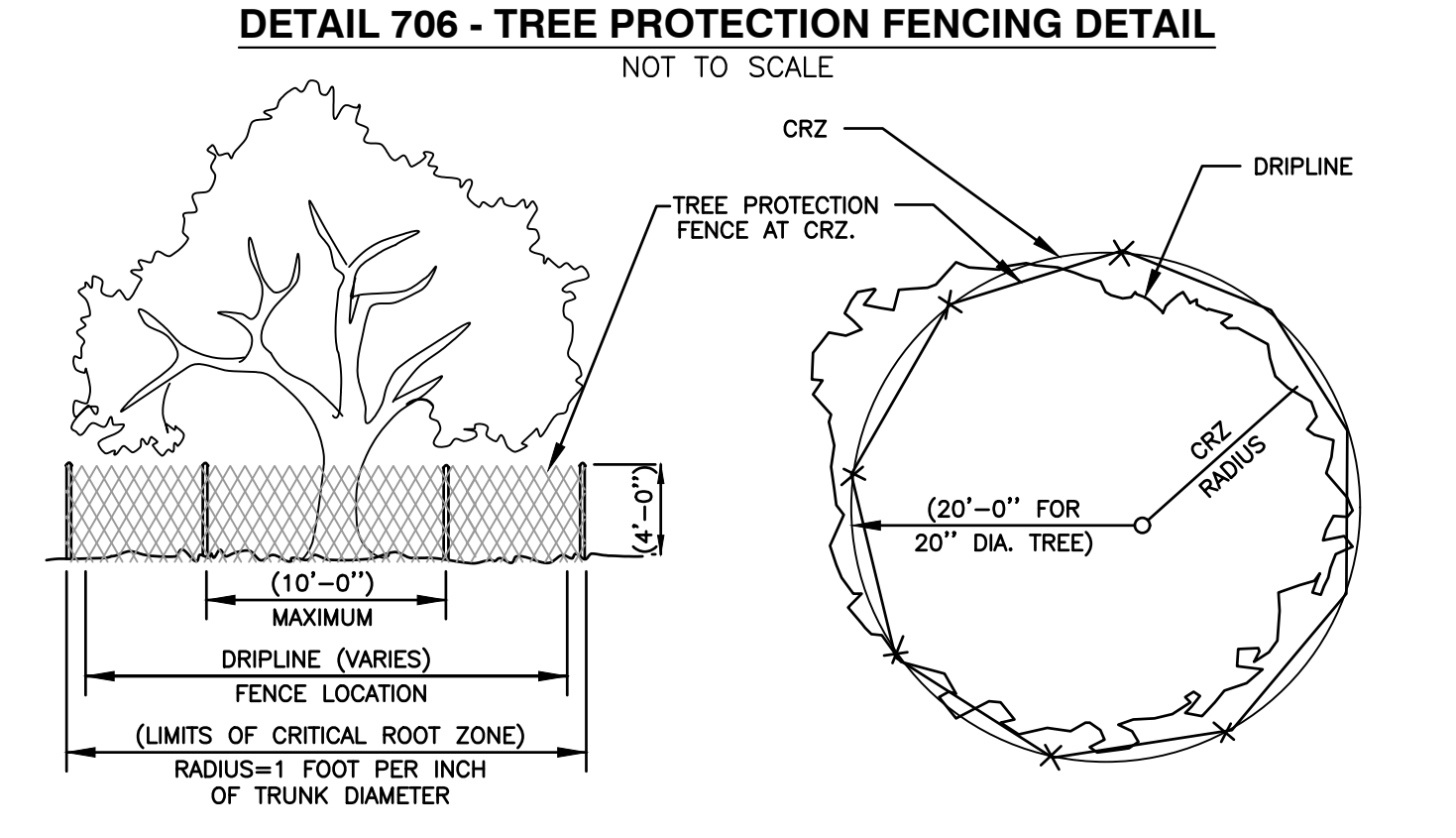
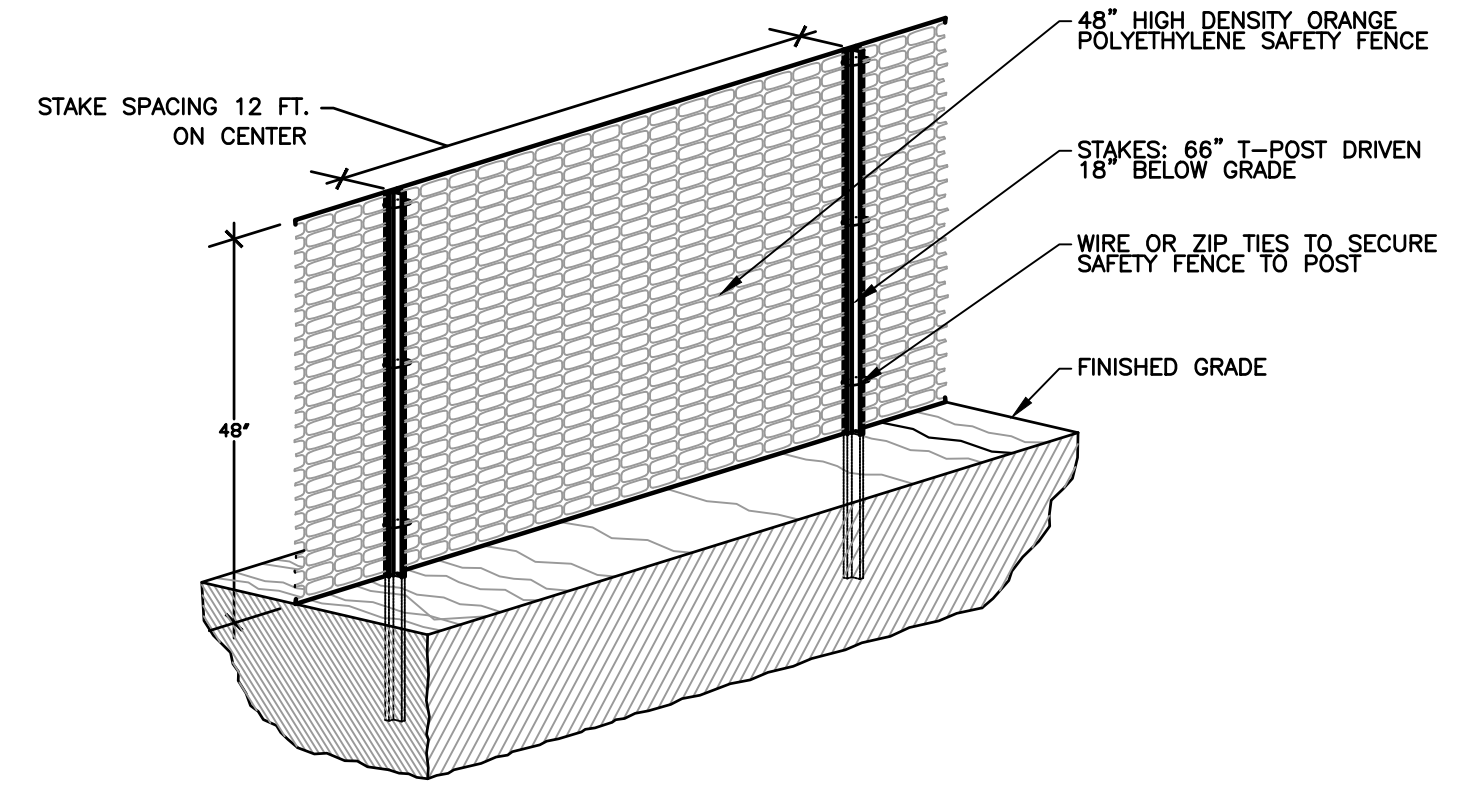

DETAIL 705 - TREE PROTECTION DETAIL
NOT TO SCALE

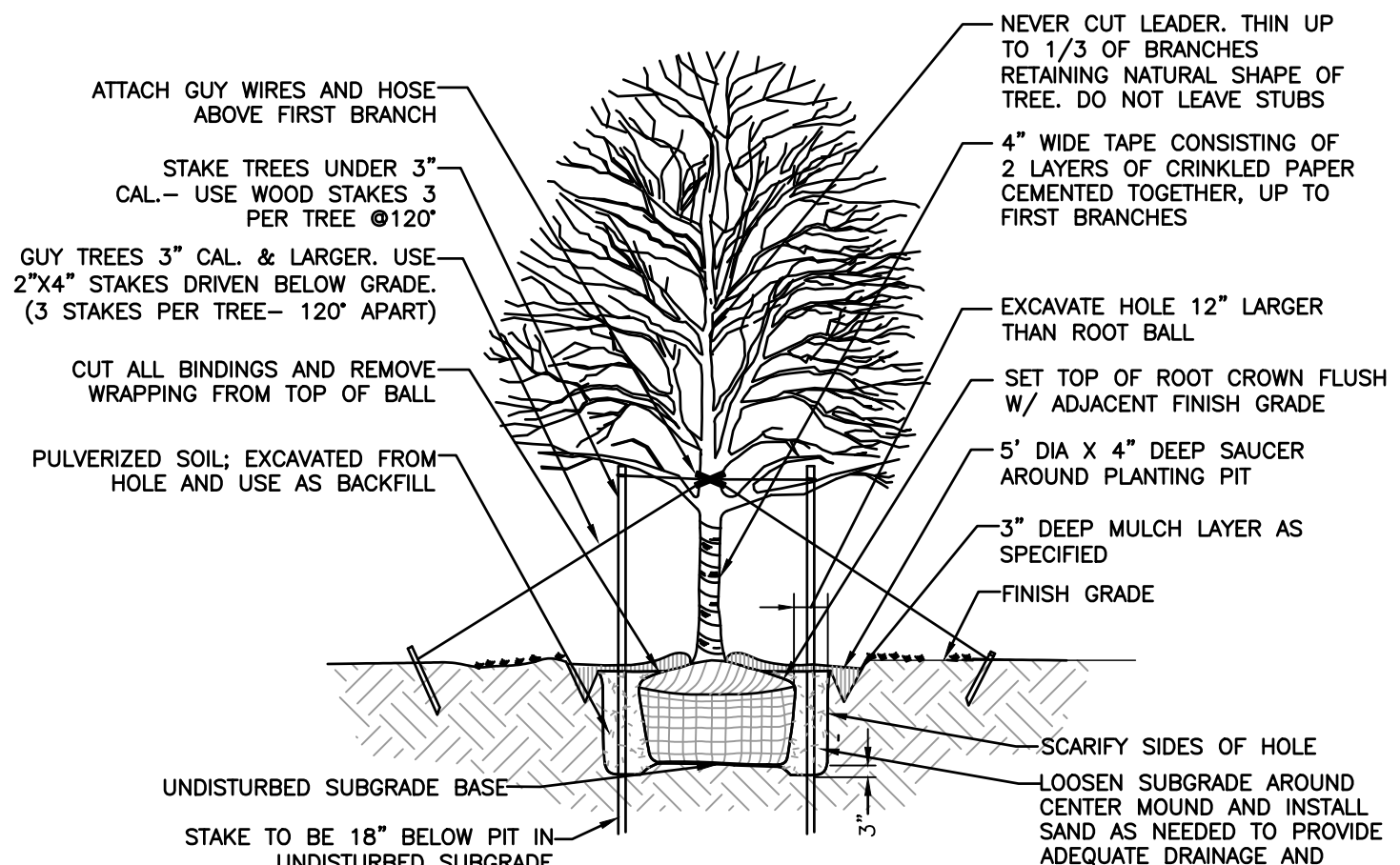

DETAIL 700 - SHADE TREE PLANTING DETAIL
NOT TO SCALE

| NO. | DATE | DESCRIPTION |
|-----|------|-------------|
| | | |
| | | |

Civil & Environmental Consultants, Inc.
250 Old Wilson Bridge Road · Suite 250 · Worthington, OH 43085
614-540-6633 · 888-598-6808
www.cecinc.com

GEIGER EXCAVATING, INC
CITY OF GAHANNA
FRANKLIN COUNTY, OHIO

SITE LANDSCAPE PLAN DETAILS

| | |
|---------------------|---------------|
| DATE: JUNE 2018 | DRAWN BY: NSA |
| DWG SCALE: AS NOTED | CJA |
| PROJECT NO: 180-632 | D BY: CJA |
| APPROVED BY: | 180-632 |

DRAWING NO.: **C701**

FINAL DEVELOPMENT PLAN GEIGER EXCAVATION INC. SOUTHPARK

CITY OF GAHANNA, COUNTY OF FRANKLIN, STATE OF OHIO
JULY 2018

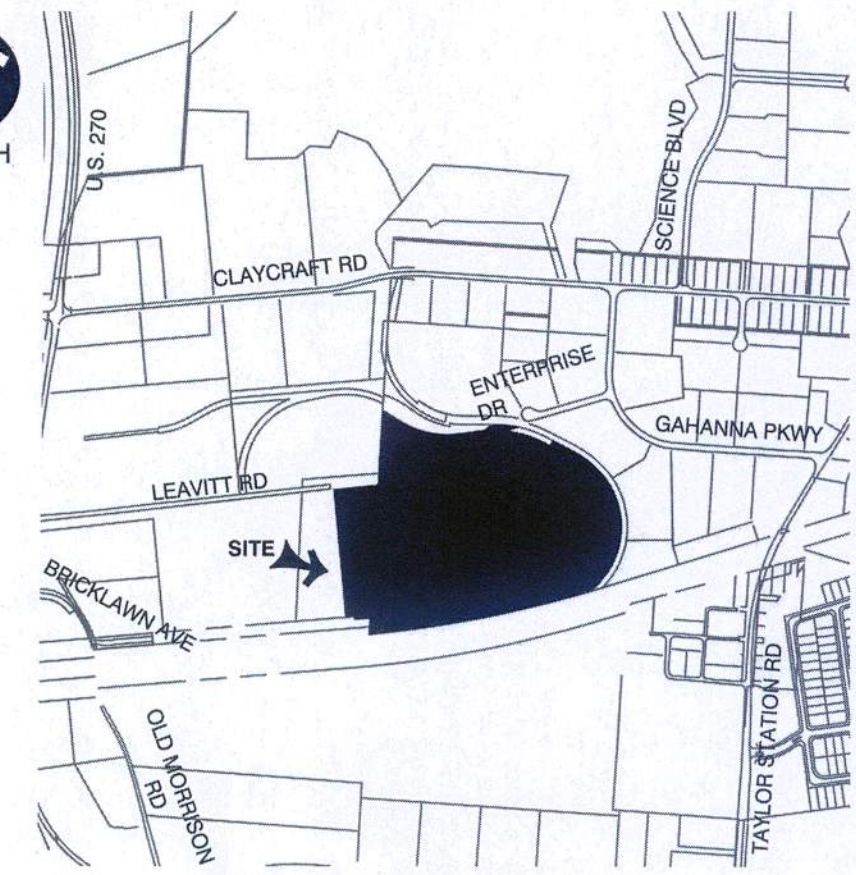

VICINITY MAP
1" = 1000'

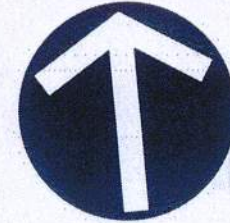

SCALE IN FEET
0 100 200

LEGEND

| | |
|--|---------------------------|
| | EXISTING SANITARY |
| | EXISTING SANITARY MANHOLE |
| | EXISTING STORM |
| | EXISTING STORM MANHOLE |
| | EXISTING WATER |
| | EXISTING FIRE HYDRANT |
| | EXISTING STREAM |
| | EXISTING FLOODPLAIN |
| | PROPERTY LINE |
| | RIGHT-OF-WAY |
| | PROPOSED SANITARY |
| | PROPOSED SANITARY MANHOLE |
| | PROPOSED STORM |
| | PROPOSED CATCH BASIN |
| | PROPOSED WATER |
| | PROPOSED FIRE HYDRANT |



SITE PLAN
SCALE: 1"=100'

SITE STATISTICS

| | |
|--------------------------|--|
| TOTAL ACREAGE | ±28.90 AC |
| ZONING | OFFICE, COMMERCIAL & TECHNOLOGY DIST (OCT) |
| BUILDING SETBACKS | |
| FRONT YARD | 75 FT |
| SIDE YARD | 25 FT |
| REAR YARD | 30 FT |
| PARKING SETBACKS | |
| PUBLIC RIGHT-OF-WAYS | 45 FT |
| SIDE AND REAR SETBACKS | 10 FT |
| SQUARE FOOTAGE OF SITE | 1,258,884 FT ² |
| PERVIOUS AREA | 1,232,601 FT ² |
| BUILDING | 7,425 FT ² |
| PARKING/DRIVES | 46,018 FT ² |
| SIDEWALK | 80 FT ² |
| IMPERVIOUS AREA | 53,503 FT ² |

PARKING DATA

| | |
|---------------------------|---|
| BUILDING SQUARE FOOTAGE | 7,425 FT ² |
| NUMBER OF SPACES REQUIRED | 8 (7,425FT ² /1000FT ² PER SPACE) |
| NUMBER OF SPACES PROVIDED | 8 (1 HANDICAP) |

REFERENCES

- EXISTING BOUNDARY AND TOPOGRAPHIC INFORMATION IS PER SURVEY PERFORMED BY CIVIL & ENVIRONMENTAL CONSULTANTS INC. ON 6/4/2018
- AERIAL PHOTOGRAPHY PROVIDED BY USGS EARTHSTAR GEOGRAPHICS SID COPYRIGHT 2017 MICROSOFT CORPORATION, IMAGE DATE JUNE 2018

OWNER/DEVELOPER
GEIGER EXCAVATING, INC
1041 ENTERPRISE DRIVE
GAHANNA, OHIO 43230
PHONE: (614) 206-2617

ENGINEER/SURVEYOR
CIVIL & ENVIRONMENTAL CONSULTANTS, INC.
250 OLD WILSON BRIDGE ROAD, SUITE 250
WORTHINGTON, OHIO 43085
PHONE: (614) 540-6633
CONTACT: BRIAN BURKHART
EMAIL: BBURKHART@CECINC.COM

- 4'-5' WHITE PINE PLANTED FOR 2017 B2A REQUIREMENT
- EXISTING TREES NOT BEING REMOVED.
- PHOTO'S NUMBERED TO LOCATION TAKEN (DIRECTIONAL INFO. ON PHOTO INFO.)

REVISION RECORD

| NO | DATE | DESCRIPTION |
|----|------|-------------|
| | | |
| | | |
| | | |
| | | |
| | | |
| | | |
| | | |
| | | |
| | | |

GEIGER EXCAVATING, INC
CITY OF GAHANNA
FRANKLIN COUNTY, OHIO

FINAL DEVELOPMENT PLAN

| | | | |
|--------------|-----------|--------------|-----|
| DATE: | JUNE 2018 | DRAWN BY: | NSA |
| DWG SCALE: | | CHECKED BY: | CJA |
| PROJECT NO.: | 180-632 | APPROVED BY: | |

DRAWING NO.:
C000
SHEET 1 OF 1



Photograph 1: Enterprise looking past Hedge Landscape on left into Geiger Excavating on left.



Photograph 2: Hedge Entrance looking into Geiger Excavating.



Civil & Environmental Consultants, Inc.

Worthington, OH 43085

Phone: 614-540-6633 Toll Free: 888-598-6808

**Geiger Excavating
South Park
Gahanna, Ohio
CEC Project 152-227**

Photographs Taken on August 27, 2018



Photograph 3: Geiger Entrance to left of Enterprise USALCO gate ahead.



Photograph 4: Geiger Entrance off Enterprise looking west. Geiger Excavation on left.



Civil & Environmental Consultants, Inc.

Worthington, OH 43085

Phone: 614-540-6633 Toll Free: 888-598-6808

**Geiger Excavating
South Park
Gahanna, Ohio
CEC Project 152-227**

Photographs Taken on August 27, 2018



Photograph 5: Geiger entrance looking east toward hedge. Geiger Excavating on right.



Photograph 6: Geiger Entrance looking south into Geiger Excavating.



Civil & Environmental Consultants, Inc.

Worthington, OH 43085

Phone: 614-540-6633 Toll Free: 888-598-6808

**Geiger Excavating
South Park
Gahanna, Ohio
CEC Project 152-227**

Photographs Taken on August 27, 2018



Photograph 7: Rail looking east toward hedge. Geiger Excavating on right.



Photograph 8: Rail looking east toward USALCO. Geiger Excavating on Left.



Civil & Environmental Consultants, Inc.

Worthington, OH 43085

Phone: 614-540-6633 Toll Free: 888-598-6808

**Geiger Excavating
South Park
Gahanna, Ohio
CEC Project 152-227**

Photographs Taken on August 27, 2018



Photograph 9: Rail looking south into Geiger Excavating.



Photograph 10: Rail looking east into Geiger Excavating.



Civil & Environmental Consultants, Inc.

Worthington, OH 43085

Phone: 614-540-6633 Toll Free: 888-598-6808

**Geiger Excavating
South Park
Gahanna, Ohio
CEC Project 152-227**

Photographs Taken on August 27, 2018



Photograph 11: Rail looking past hedge.



Photograph 12: Rail looking toward USALCO.



Civil & Environmental Consultants, Inc.

Worthington, OH 43085

Phone: 614-540-6633 Toll Free: 888-598-6808

**Geiger Excavating
South Park
Gahanna, Ohio
CEC Project 152-227**

Photographs Taken on August 27, 2018



Photograph 13: Rail west into Geiger Excavating.



Photograph 14: Rail south toward RTP.



Civil & Environmental Consultants, Inc.

Worthington, OH 43085

Phone: 614-540-6633 Toll Free: 888-598-6808

**Geiger Excavating
South Park
Gahanna, Ohio
CEC Project 152-227**

Photographs Taken on August 27, 2018



Photograph 15: Rail north toward hedge.



Photograph 16: Rail south past RTP.



Civil & Environmental Consultants, Inc.
Worthington, OH 43085
Phone: 614-540-6633 Toll Free: 888-598-6808

**Geiger Excavating
South Park
Gahanna, Ohio
CEC Project 152-227**

Photographs Taken on August 27, 2018



Photograph 17: Rail north.



Photograph 18: Rail south toward rail split.



Civil & Environmental Consultants, Inc.

Worthington, OH 43085

Phone: 614-540-6633 Toll Free: 888-598-6808

**Geiger Excavating
South Park
Gahanna, Ohio
CEC Project 152-227**

Photographs Taken on August 27, 2018



Photograph 19: Rail west toward split.



Photograph 20: Rail north into Geiger Excavating.



Civil & Environmental Consultants, Inc.

Worthington, OH 43085

Phone: 614-540-6633 Toll Free: 888-598-6808

**Geiger Excavating
South Park
Gahanna, Ohio
CEC Project 152-227**

Photographs Taken on August 27, 2018



Photograph 21: Rail northwest into Geiger Excavating.



Photograph 22: Rail west toward Bricklawn Avenue.



Civil & Environmental Consultants, Inc.

Worthington, OH 43085

Phone: 614-540-6633 Toll Free: 888-598-6808

**Geiger Excavating
South Park
Gahanna, Ohio
CEC Project 152-227**

Photographs Taken on August 27, 2018



Photograph 23: Rail east toward rail split.



Photograph 24: Rail north into Geiger Excavating.



Civil & Environmental Consultants, Inc.

Worthington, OH 43085

Phone: 614-540-6633 Toll Free: 888-598-6808

**Geiger Excavating
South Park
Gahanna, Ohio
CEC Project 152-227**

Photographs Taken on August 27, 2018



Photograph 25: Rail north into Geiger Excavating.



Photograph 26: Rail west toward Bricklawn Avenue.



Civil & Environmental Consultants, Inc.

Worthington, OH 43085

Phone: 614-540-6633 Toll Free: 888-598-6808

**Geiger Excavating
South Park
Gahanna, Ohio
CEC Project 152-227**

Photographs Taken on August 27, 2018



Photograph 27: Leavitt Service Road half way (Arrow on left).



Photograph 28: Geiger entrance of Leavitt Service Road (looking left).



Civil & Environmental Consultants, Inc.

Worthington, OH 43085

Phone: 614-540-6633 Toll Free: 888-598-6808

**Geiger Excavating
South Park
Gahanna, Ohio
CEC Project 152-227**

Photographs Taken on August 27, 2018



Photograph 29: Geiger Excavating entrance of Leavitt Service Road (looking straight).



Photograph 30: Geiger Excavating entrance of Leavitt Service Road (looking right).



Civil & Environmental Consultants, Inc.

Worthington, OH 43085

Phone: 614-540-6633 Toll Free: 888-598-6808

**Geiger Excavating
South Park
Gahanna, Ohio
CEC Project 152-227**

Photographs Taken on August 27, 2018



Photograph 31: Geiger Excavating entrance of Leavitt Service Road (farther right).

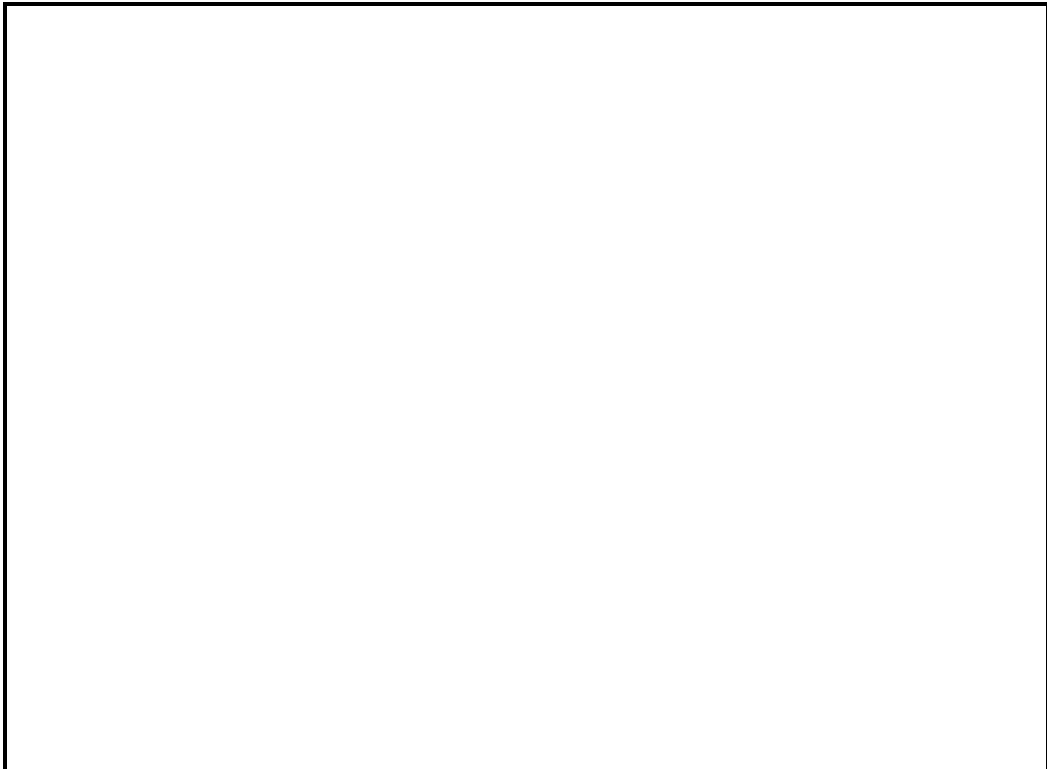

Civil & Environmental Consultants, Inc.

Worthington, OH 43085

Phone: 614-540-6633 Toll Free: 888-598-6808

**Geiger Excavating
South Park
Gahanna, Ohio
CEC Project 152-227**

Photographs Taken on August 27, 2018



September 21, 2018

Geiger Excavating Inc
Po Box 307717
Columbus, OH 43230

RE: Project 0 Leavitt Service Rd, 1041 Enterprise Dr, 960 Bricklawn Ave Final Development Plan

Dear Geiger Excavating Inc:

The following comments were generated from the review of the submitted plans and documents for the referenced project. For the next submittal, please provide a disposition of comments, revised plans, and/or other information as requested for further review. The disposition of comments needs to include both the original comment and the appropriate response. If desired, these comments can be emailed. Re-submitted plans that do not include the disposition of comments document will not be reviewed and will be returned to you.

Building

1. The structure will be required to comply with the Ohio Building Code, including accessibility, all Building permits will be required for the structure, and accessible parking provided.

Public Safety

2. No comments or concerns from the police department.

Fire District

3. The above listed plan complies with the Section 503 of the 2017 Ohio Fire Code. The fire apparatus access roadway is 24 feet wide in acceptable locations. The width is adequate if the height of the building is under 30 feet. The roadway increases to 26 feet if the height is over 30 feet. There is one existing hydrant and what appears to be one proposed hydrant. The fire flow for the building is 2,250 GPM if it is V B construction. The hydrants shall provide a fire flow of approximately 2000 GPM.

The Fire Division approves this project plan.

Additional requirements and comments could follow after plans are submitted and the review process starts

Public Service & Engineering

4. General Comments
 - A formal final engineering plan review will be required following approval of the Final Development Plan (FDP), or concurrently with the FDP process if requested by the Developer at their risk.

- The developer will be responsible for the vacation of any easements and or right-of-way necessary for the development.

5. Site Access

- Any development that may generate more than 100 vehicle trips in the peak hour, or more than 1,000 total trips in a 24 hour period, will require that a Traffic Impact Study be completed and submitted to our office for review. The applicant shall provide a letter from a registered professional engineer certifying the site trip generation.
- Two access drives are shown for the project. One is proposed from Leavitt Service Road, and the other is proposed from Bricklawn Avenue.
- There appears to be an indication of access to Enterprise Drive on the north side of the site. Enterprise drive shall not be used for a primary means of ingress and egress to the facility, however, it may be used for emergency access purposes only. The site plan shall be revised to show that the access to Enterprise Drive shall be for emergency purposes only. The applicant should consider a change of address to reflect a Leavitt Service Road, or Bricklawn Avenue address to provide better navigation and avoid folks attempting to use Enterprise Drive as the primary means of access.
- There are proposed drives that are unpaved. This will require a variance. If the variance is granted, the owner shall provide and maintain measures to adequately address dust control. The dust control measures shall address the entire site to reduce dust from affecting adjoining property owners.

6. Sanitary Sewer

- There is an existing 8 inch sanitary sewer located along the southern property line that can be accessed to provide sanitary sewer service for the development.
- The provided plan indicates a main line extension. This will require a separate final engineering plan submittal and will require all necessary permits and approvals.

7. Water Service

- There is an existing 8 inch waterline located along the southern property line that can be accessed to provide water service for the development.
- The provided plan indicates a main line extension. This will require a separate final engineering plan submittal and will require all necessary permits and approvals.

8. Stormwater Management

- Storm water detention and water quality requirements shall be addressed on-site. Detention and water quality treatment design to be per City of Gahanna standards, Codified Ordinances Chapter 1193, and 1195.
- We recommend that strong consideration be given to incorporating green infrastructure best management practices (BMP's) for detention and water quality measures.
- Erosion Control design and Post Construction Runoff Control to be per City of Gahanna (Chapter 1195) and Franklin Soil and Water Conservation District requirements.

Soil & Water Conservation District

9. No Comment Received

Page 3 of 3

September 26, 2018

**Re: Project 0 Leavitt Service Rd, 1041 Enterprise Dr, 960 Bricklawn Ave
0 Leavitt Service Rd, 1041 Enterprise Dr, 960 Bricklawn Ave**

If you have any comments or questions, please contact me at kelly.wicker@gahanna.gov or (614) 342-4025.

Sincerely,

Kelly Wicker
Administrative Assistant

RE: Project 0 Leavitt Service Rd, 1041 Enterprise Dr, 960 Bricklawn Ave
Geiger Excavating Inc
CEC Project 180-632
Final Development Plan Comment Letter

Civil & Environmental Consultants, Inc. (CEC) has received the review comments from Gahanna via email dated September 21, 2018 for Geiger Excavating and CEC has prepared the following responses the comments which were italicized and underlined.

Building

1. The structure will be required to comply with the Ohio Building Code, including accessibility, all Building permits will be required for the structure, and accessible parking provided.

Noted.

Public Safety

2. No comments or concerns from the police department.

Noted.

Community Development

3. CH 914 requires one shade tree caliper inch per 1,000 square feet of impervious surface. The FDP indicates an impervious surface area of 53,503 square feet which requires 54 inches of either planted or preserved trees. Please refer to Chapter 914.05 for more information regarding minimum trees required. Please be aware that a landscape plan will be required to depict planting and/or preserved trees.

9/21/18 - A landscape plan has been submitted that depicts Eastern White Pines being planted to meet the shade tree planting requirements of CH914. Staff does not believe that these trees meet the definition of a shade tree. Staff recommends species such as honey locust, oaks, maples, and other large deciduous trees to meet this requirement. Please be aware that the request can move forward as submitted but the staff will recommend to Planning Commission a different species type other than a pine.

Noted. The species of tree has been revised per staff comment.

Fire District

4. The above listed plan complies with the Section 503 of the 2017 Ohio Fire Code. The fire apparatus access roadway is 24 feet wide in acceptable locations. The width is adequate if the height of the building is under 30 feet. The roadway increases to 26 feet if the height is over 30 feet.

There is one existing hydrant and what appears to be one proposed hydrant. The fire flow for the building is 2,250 GPM if it is V B construction. The hydrants shall provide a fire flow of approximately 2000 GPM.

The Fire Division approves this project plan.

Additional requirements and comments could follow after plans are submitted and the review process starts.

Noted.

Public Service & Engineering

5. General Comments

- A formal final engineering plan review will be required following approval of the Final Development Plan (FDP), or concurrently with the FDP process if requested by the Developer at their risk.

Noted.

- The developer will be responsible for the vacation of any easements and or right-of-way necessary for the development.

Noted.

6. Site Access

Any development that may generate more than 100 vehicle trips in the peak hour, or more than 1,000 total trips in a 24 hour period, will require that a Traffic Impact Study be completed and submitted to our office for review. The applicant shall provide a letter from a registered professional engineer certifying the site trip generation.

Noted. Geiger Excavating generates approximately ~100 trips or less per day and would request that a traffic impact study not be required for this development.

- Two access drives are shown for the project. One is proposed from Leavitt Service Road, and the other is proposed from Bricklawn Avenue.

Noted.

- There appears to be an indication of access to Enterprise Drive on the north side of the site. Enterprise drive shall not be used for a primary means of ingress and egress to the facility, however, it may be used for emergency access purposes only. *The site plan shall be revised to show that the access to Enterprise Drive shall be for emergency purposes only. The*

applicant should consider a change of address to reflect a Leavitt Service Road, or Bricklawn Avenue address to provide better navigation and to avoid attempting to use Enterprise Drive as the primary means of access.

Site plan revised. Emergency access only added to the callout.

- There are proposed drives that are unpaved. This will require a variance. If the variance is granted, the owner shall provide and maintain measures to adequately address dust control. The dust control measures shall address the entire site to reduce dust from affecting adjoining property owners.

Noted. The dust control plan shall be for the entire site. Please see attached dusts control schedule.

7. Sanitary Sewer

- There is an existing 8 inch sanitary sewer located along the southern property line that can be accessed to provide sanitary sewer service for the development.

Adjusted final development plan to only show service from main. If possible a long service with cleanout shall be provided for this development.

- The provided plan indicates a main line extension. This will require a separate final engineering plan submittal and will require all necessary permits and approvals.

Adjusted final development plan to only show service from main. If possible a long service with cleanout shall be provided for this development

8. Water Service

There is an existing 8 inch waterline located along the southern property line that can be accessed to provide water service for the development.

Adjusted final development plan to only show service from main.

- The provided plan indicates a main line extension. This will require a separate final engineering plan submittal and will require all necessary permits and approvals.

Adjusted final development plan to only show service from main.

9. Stormwater Management

- Storm water detention and water quality requirements shall be addressed on-site. Detention and water quality treatment design to be per City of Gahanna standards, Codified Ordinances Chapter 1193, and 1195.

Noted.

- We recommend that strong consideration be given to incorporating green infrastructure best management practices (BMP's) for detention and water quality measures.

Existing basin to be used to provide for storm water detention and water quality

requirements.

- Erosion Control design and Post Construction Runoff Control to be per City of Gahanna (Chapter 1195) and Franklin Soil and Water Conservation District requirements.

Noted.

Soil & Water Conservation District

10. No Comment Received.

Noted.

Parks

11. *The only concern I have with this application is the diagram of tree planting instructions. The diagram indicates that the root crown should be 4" above finished grade. Industry standards, however, suggest that the root flare should taper off at ground level. I just want to be sure that the trees will not be planted too high. This link to the Arbor Day Foundation outlines proper tree planting technique.*

<https://www.arborday.org/trees/planting/balled-burlapped.cfm>

Adjusted detail so that the root crown lower to taper off at ground level.

Please do not hesitate to contact me regarding any questions you may have. Sincerely,

CIVIL & ENVIRONMENTAL CONSULTANTS, INC.

Carl Arthur, P.E.

Project Manager

Enclosures

PLANNING AND DEVELOPMENT STAFF REPORT

Request Summary

The applicant requests Conditional Use (CU), Final Development Plan (FDP), Design Review (DR), and Variance application approval in order to continue the recycling operations ongoing at the subject property. The property has been subject to a number of conditional use requests over the last eight years in order to cap the landfill. Previous requests differ from this request as this request is to permit the recycling operations on a permanent, rather than temporary, basis.

If the applications are approved by Planning Commission, there will be minimal changes to the site since it operates in a similar fashion today. The addition of a 7,425 square foot building and staff's recommendation to eliminate access onto Enterprise Drive would be the most notable changes to the site. City staff strongly urge the elimination of access onto Enterprise as we are aware of dust complaints from neighboring property owners. Elimination of access onto Enterprise should substantially reduce adverse effects of the operations onsite.



Conditional Use

The main activities occurring onsite are for the outdoor storage of materials. Outdoor storage is only permissible by conditional use within the Office, Commerce, and Technology (OCT) zone district. The site has had a number of similar requests approved in recent years, however, these approvals were



always on a temporary basis. Approvals were usually good for up to two years. This request is to allow the use on a permanent basis, therefore there is no timeframe associated with this request. However, permanent improvements are required such as paved drives and landscaping.

Requests for a conditional use shall be approved if the following four conditions are met:

1. The proposed use is a conditional use of the zoning district and the applicable development standards established in this zoning ordinance are met.
2. The proposed development is in accord with the appropriate plans for the area.
3. The proposed development will not have undesirable effects on the surrounding area.
4. The proposed development will be in keeping with the existing land use character and physical development potential of the area.

It is staff's opinion that the request meets the four conditions of approval and therefore recommends approval of the request. Staff recommends that the conditional use specify that Enterprise Drive may only be used for emergency access purposes. This will allow fire and emergency vehicles to use the access if necessary but not everyday traffic. This condition should help minimize dust from impacting adjacent properties.

Final Development Plan

Planning Commission shall approve an FDP application if the following four conditions are met:

- A. The proposed development meets the applicable development standards of this Zoning Ordinance.
- B. The proposed development is in accord with appropriate plans for the area.
- C. The proposed development would not have undesirable effects on the surrounding area.
- D. The proposed development would be in keeping with the existing land use character and physical development potential of the area.

Design Review

The property is zoned OCT and therefore subject to the standards of Design Review District 4 (DRD-4). Relevant standards include the following:

- Parking areas shall accommodate employees and not degrade the appearance of the development and the general area.
- Access shall be limited in number.
- Building materials are important to protect property values but a more liberal standard should be applied to OCT.



Variance

Three variances are necessary in order to approve the FDP application as submitted.

1. Chapter 1155.07(b)(1) – Height of outside storage areas are limited to ten feet. The applicant is requesting a maximum height of 25'. This height is consistent with how the site has been operating the last ten or so years.
2. Chapter 1155.07(c)(1) – Outdoor storage of materials shall be screened from view from the public right-of-way or adjacent properties by the use of a wall, fence, mounding, plant materials or combination thereof.
3. Chapter 1163.05(a) – All parking areas including spaces, drives, and aisles shall be hard surfaces such as cement or concrete. The applicant proposes to have gravel drives within the outside storage areas. The site currently functions with gravel drives. Staff has visited the site and has observed a substantial amount of dust coming from the gravel drives. Staff recommends any motion to approve include the dust control measures provided by the applicant.

Planning Commission shall not grant a variance unless it finds that all of the following conditions apply:

- a) There are special circumstances or conditions applying to the land, building or use referred to in the application.
- b) The granting of the variance is necessary for the preservation and enjoyment of substantial property rights.
- c) The granting of the application will not materially affect adversely the health or safety of persons residing or working in the neighborhood of the proposed use and will not be materially detrimental to the public welfare or injurious to property or improvements in such neighborhood.

Staff understands the need for the three variances. It would appear unfeasible to fully screen storage piles if they are granted permission to be 25'. The site has a large number of pine trees that were recently planted as part of the BZBA approval that provide a fair amount of screening. Staff believes that the provided dust control measures will help lessen any offsite impact to surrounding properties but we also believe that closing the access to Enterprise is important. These two measures should substantially reduce the effects of dust from the property and therefore don't object to granting the variance.

Area Commission

The request was discussed at the May 3rd Area Commission meeting. Attached to the report is feedback from the area commission meeting. Please note that Area Commission feedback is non-binding.

Recommendation

It is Planning and Development staff's opinion that the requested applications are generally consistent with the development potential of the property and applicable area plans. Staff does have concerns about dust that has been generated from the site. The City is aware that adjacent properties have complained about the impact of the project to their operation. Staff has been to the area and observed the situation. It appears that a majority of dust is being generated from trucks entering and exiting the

site via Enterprise Drive. Internal drives, which are gravel, and Enterprise, which is paved, appear to generate more dust than the processing and storage of materials. With the closing of Enterprise Drive and the submitted dust control measures, staff believes that the site will no longer negatively impact surrounding properties.

Location/Zoning Map

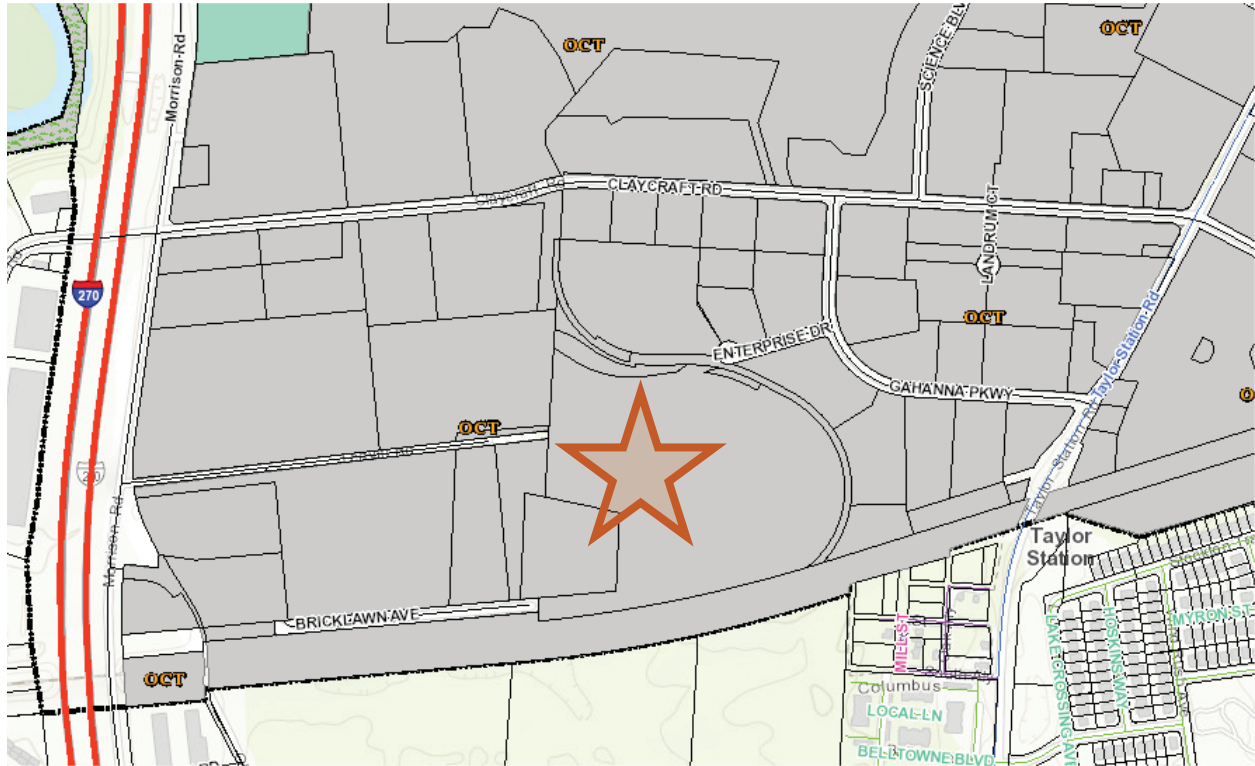

Respectfully Submitted By:
Michael Blackford, AICP
Deputy Director

Area Commission Feedback

Gahanna Area Commission Framework

COMMISSION FEEDBACK CRITERIA

Project name:

SOUTHPARK ACCU-02-18

Meeting date:

5/3/2018

Project type:

- Annexation
- Conditional Use
- Zoning Change (rezoning)
- Other _____

Reviewer name:

JOHN WILLIAMS

Reviewer status:

- Commission Member
- General Public

Does the scale and use of the proposal fit the context of the surrounding neighborhood?

YES; 30' VARIANCE FOR HEIGHT OF MATERIAL

How would you improve the proposal as submitted?

What do you see as some of the outcomes of the proposal?

EXPANSION OF OPERATION; HIRING ADDITIONAL EMPLOYEES; CONSTRUCTION OF 60x100' OFFICE/STORAGE

What are your overall comments or suggestions?

THE COMPANY IS PROVIDING USEFUL CONSTRUCTION SERVICES WHILE REDUCING RECYCLING MATERIAL AND KEEPING IT OUT OF LANDFILLS.

| Please rate the following aspects of the proposal for its level of appropriateness or inappropriateness for its context and for the City of Gahanna: | Not appropriate or desirable | | Very appropriate and desirable | | | N/A |
|--|------------------------------|---|--------------------------------|----|---|-----|
| | ← | | → | | | |
| | 1 | 2 | 3 | 4 | 5 | |
| Pedestrian friendliness | | | | | | X |
| Scale | | | | XX | | |
| Compatibility with surrounding uses | | | | XX | | |
| Vehicular circulation | | | | | | X |
| Traffic impact on neighboring streets | | | X | | | |

Gahanna Area Commission Framework

COMMISSION FEEDBACK CRITERIA

Project name:

Southpark

Meeting date:

5/3/18

Project type:

- Annexation
 Conditional Use
 Zoning Change (rezoning)
 Other

Reviewer name:

Ron Smith

Reviewer status:

- Commission Member
 General Public

Does the scale and use of the proposal fit the context of the surrounding neighborhood?

The applicant has demonstrated the ease of use of this property on a temporary basis, making it permanent makes sense.

How would you improve the proposal as submitted?

Showing floor plan, or designs, for office/warehouse proposed for the land use.

What do you see as some of the outcomes of the proposal?

I see the company submitting the proposal having a good history of operating on this parcel, and have a good understanding on how that parcel can continue to be used. I would approve the permanent use.

What are your overall comments or suggestions?

This would benefit the city from an Economic Development stand point, where these materials can be used locally, and we can support their business through purchasing product for local projects.

| Please rate the following aspects of the proposal for its level of appropriateness or inappropriateness for its context and for the City of Gahanna: | Not appropriate or desirable | | Very appropriate and desirable | | | N/A |
|--|------------------------------|---|--------------------------------|---|---|-----|
| | ← | | → | | | |
| | 1 | 2 | 3 | 4 | 5 | |
| Pedestrian friendliness | | | | | | x |
| Scale | | | | | x | |
| Compatibility with surrounding uses | | | | | x | |
| Vehicular circulation | | | | | x | |
| Traffic impact on neighboring streets | | | | | x | |

Gahanna Area Commission Framework

COMMISSION FEEDBACK CRITERIA

Project name:

*Change from temp to perm
landfill*

Meeting date:

May 3, 2018

Project type:

- Annexation
- Conditional Use
- Zoning Change (rezoning)
- Other _____

Reviewer name:

Diana M Sedman

Reviewer status:

- Commission Member
- General Public

Does the scale and use of the proposal fit the context of the surrounding neighborhood?

Sounds like it should be acceptable

How would you improve the proposal as submitted?

What do you see as some of the outcomes of the proposal?

Continued business model that has proved successful

What are your overall comments or suggestions?

See no reason not to move ahead

Please rate the following aspects of the proposal for its level of appropriateness or inappropriateness for its context and for the City of Gahanna:

| | Not appropriate or desirable | | Very appropriate and desirable | | | N/A |
|---------------------------------------|------------------------------|---|--------------------------------|-------------------------------------|-------------------------------------|-------------------------------------|
| | ← | | | → | | |
| | 1 | 2 | 3 | 4 | 5 | |
| Pedestrian friendliness | | | | | | <input checked="" type="checkbox"/> |
| Scale | | | | <input checked="" type="checkbox"/> | | |
| Compatibility with surrounding uses | | | | <input checked="" type="checkbox"/> | | |
| Vehicular circulation | | | | | <input checked="" type="checkbox"/> | |
| Traffic impact on neighboring streets | | | | | <input checked="" type="checkbox"/> | |